

Алматы (7273)495-231
Ангарск (3955)60-70-56
Архангельск (8182)63-90-72
Астрахань (8512)99-46-04
Барнаул (3852)73-04-60
Белгород (4722)40-23-64
Благовещенск (4162)22-76-07
Брянск (4832)59-03-52
Владивосток (423)249-28-31
Владикавказ (8672)28-90-48
Владимир (4922)49-43-18
Волгоград (844)278-03-48
Вологда (8172)26-41-59
Воронеж (473)204-51-73
Екатеринбург (343)384-55-89

Иваново (4932)77-34-06
Ижевск (3412)26-03-58
Иркутск (395)279-98-46
Казань (843)206-01-48
Калининград (4012)72-03-81
Калуга (4842)92-23-67
Кемерово (3842)65-04-62
Киров (8332)68-02-04
Коломна (4966)23-41-49
Кострома (4942)77-07-48
Краснодар (861)203-40-90
Красноярск (391)204-63-61
Курск (4712)77-13-04
Курган (3522)50-90-47
Липецк (4742)52-20-81

Магнитогорск (3519)55-03-13
Москва (495)268-04-70
Мурманск (8152)59-64-93
Набережные Челны (8552)20-53-41
Нижний Новгород (831)429-08-12
Новокузнецк (3843)20-46-81
Ноябрьск (3496)41-32-12
Новосибирск (383)227-86-73
Омск (3812)21-46-40
Орел (4862)44-53-42
Оренбург (3532)37-68-04
Пенза (8412)22-31-16
Петрозаводск (8142)55-98-37
Псков (8112)59-10-37

Пермь (342)205-81-47
Ростов-на-Дону (863)308-18-15
Рязань (4912)46-61-64
Самара (846)206-03-16
Саранск (8342)22-96-24
Санкт-Петербург (812)309-46-40
Саратов (845)249-38-78
Севастополь (8692)22-31-93
Симферополь (3652)67-13-56
Смоленск (4812)29-41-54
Сочи (862)225-72-31
Ставрополь (8652)20-65-13
Сургут (3462)77-98-35
Сыктывкар (8212)25-95-17
Тамбов (4752)50-40-97

Тверь (4822)63-31-35
Тольятти (8482)63-91-07
Томск (3822)98-41-53
Тула (4872)33-79-87
Тюмень (3452)66-21-18
Ульяновск (8422)24-23-59
Улан-Удэ (3012)59-97-51
Уфа (347)229-48-12
Хабаровск (4212)92-98-04
Чебоксары (8352)28-53-07
Челябинск (351)202-03-61
Череповец (8202)49-02-64
Чита (3022)38-34-83
Якутск (4112)23-90-97
Ярославль (4852)69-52-93

Россия +7(495)268-04-70

Казахстан +7(7172)727-132

Киргизия +996(312)96-26-47

www.fourwinds.nt-rt.ru | | fse@nt-rt.ru

Технические характеристики на регулируемые скользящие ножки, напольные опоры для скольжения, подпятники, накладки, бамперы компании **Four Winds**

Виды товаров: регулируемые скользящие ножки, напольные опоры для скольжения, подпятники, накладки, пластиковые бамперы для мебели, самоклеящиеся бамперы, нейлоновые, алюминиевые, пластиковые, металлические и др.

11-3 Adjustable Floor Glides

5390 Adjustable Floor Glide

- * PE flat base, white, black, beige, brown or grey, rigid type
- * Without metal shell
- * Dimensions of threaded stem to be specified

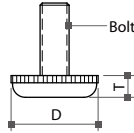

Item No.	Dia. (D)	Thick (T)
53902	Ø16mm (5/8")	5.7mm
53903	Ø19mm (3/4")	6.0mm
53904	Ø22mm (7/8")	6.0mm
53905	Ø24mm (15/16")	6.0mm
53906	Ø28mm (1-1/8")	6.0mm

CHARLES Adjustable Floor Glide

- * Plastic base, black, rigid type
- * Without metal shell
- * Dimensions of threaded stem to be specified

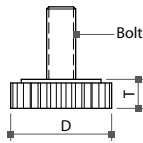

Model No.	Dia. (D)	Thick (T)
CHA116	Ø16mm	7mm
CHA120	Ø20mm	7mm
CHA122	Ø22mm	7.3mm
CHA125	Ø25mm	7.3mm
CHA128	Ø28mm	7.3mm

CHARLES-H Adjustable Floor Glide

- * Nylon base with hex collar, black, rigid type
- * Without metal shell
- * Dimensions of threaded stem to be specified

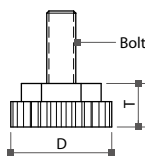

Model No.	Dia. (D)	Thick (T)
CHA222	Ø22mm	12mm
CHA225	Ø25mm	12mm
CHA228	Ø28mm	12mm

11-3 Adjustable Floor Glides

SILENCER-H Adjustable Floor Glide

- * Nylon base with hex collar, black, rigid type
- * Without metal shell
- * Dimensions of threaded stem to be specified

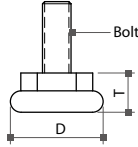

Model No.	Dia. (D)	Thick (T)
SLN123	Ø23mm	11mm
SLN126	Ø26mm	11mm
SLN131	Ø31mm	10.7mm
SLN137	Ø37mm	10.7mm



SILENCER-R Adjustable Floor Glide

- * PE base with round collar, black, rigid type
- * Without metal shell
- * Dimensions of threaded stem to be specified

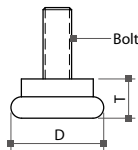

Model No.	Dia. (D)	Thick (T)
SLN225	Ø25mm	10.4mm



SILENCER-M Adjustable Floor Glide

- * Nylon base, black, rigid type
- * Metal boot, nickel or chrome plated
- * Dimensions of threaded stem to be specified

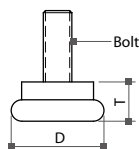

Model No.	Dia. (D)	Thick (T)
SLN423	Ø23mm	11.5mm
SLN426	Ø26mm	12mm
SLN429	Ø28.8mm	11.5mm
SLN432	Ø31.7mm	11.2mm
SLN435	Ø34.7mm	11.2mm
SLN438	Ø37.7mm	11.2mm



11-3 Adjustable Floor Glides

REGENCY Adjustable Floor Glide

- * Plastic base, black, white or grey, rigid type
- * Without metal shell
- * Dimensions of threaded stem to be specified

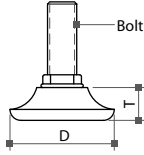

Model No.	Dia. (D)	Thick (T)
REG125	Ø25.4mm	10mm
REG128	Ø28.6mm	9mm
REG132	Ø32mm	9.5mm
REG135	Ø35mm	10mm
REG143	Ø43mm	11mm

MONTE CARLO Adjustable Floor Glide

- * Plastic base, black or white, rigid type
- * Metal shell, chrome, nickel plated or black, silver grey coated
- * Dimensions of threaded stem to be specified

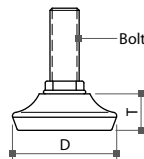

Model No.	Dia. (D)	Thick (T)
MON125	Ø25.4mm	10mm
MON128	Ø28.6mm	10mm
MON135	Ø35mm	11mm
MON143	Ø43mm	11.5mm
MON150	Ø50mm	11.5mm

TITAN Adjustable Floor Glide

- * Plastic base, black or white, rigid type
- * Metal shell, chrome, nickel plated or black, silver grey coated
- * Dimensions of threaded stem to be specified

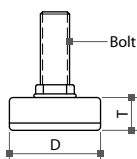

Model No.	Dia. (D)	Thick (T)
TIT25	Ø25mm	9.5mm
TIT35	Ø35mm	14mm
TIT38	Ø38mm	14mm
TIT43	Ø43mm	13.5mm
TIT60	Ø60mm	16mm
TIT75	Ø75mm	16mm

11-3 Adjustable Floor Glides

DANIEL Adjustable Floor Glide

- * Nylon base, black, rigid type
- * Stainless steel shell
- * Dimensions of threaded stem to be specified

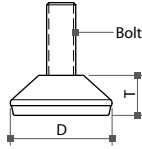

Model No.	Dia. (D)	Thick (T)
DAN121	Ø21mm	9.5mm
DAN128	Ø28mm	11mm
DAN132	Ø32mm	11mm
DAN135	Ø35mm	13.5mm
DAN138	Ø38mm	13.5mm
DAN150	Ø50mm	18mm

DANIEL Adjustable Floor Glide

- * Nylon base, black, swivel type
- * Stainless steel shell
- * Dimensions of threaded stem to be specified

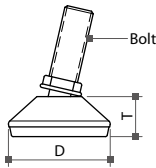

Model No.	Dia. (D)	Thick (T)
DAN230	Ø30mm	14mm
DAN240	Ø40mm	15mm
DAN245	Ø45mm	15.5mm
DAN250	Ø50mm	16mm
DAN260	Ø60mm	16.5mm

DOUGLAS Adjustable Floor Glide

- * PE base, black, white or grey, swivel type
- * Without metal shell
- * Dimensions of threaded stem to be specified

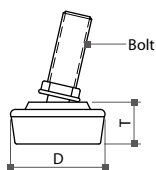

Model No.	Dia. (D)	Thick (T)
DOU126	Ø26mm	11.5mm
DOU132	Ø32mm	13.2mm
DOU138	Ø38mm	13.2mm

11-3 Adjustable Floor Glides

FLAT Adjustable Floor Glide

- * Nylon base, black, rigid type
- * Without metal shell
- * Dimensions of threaded stem to be specified

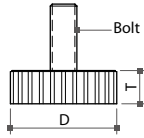

Model No.	Dia. (D)	Thick (T)
FLT132	Ø32mm	10mm
FLT135	Ø35mm	10mm
FLT140	Ø40mm	10mm
FLT150	Ø50mm	12mm
FLT160	Ø60mm	12mm
FLT180	Ø80mm	12mm



THIN Adjustable Floor Glide

- * Nylon base, black, rigid type
- * Without metal shell
- * Dimensions of threaded stem to be specified

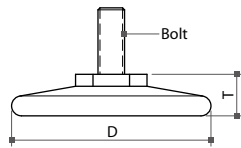

Model No.	Dia. (D)	Thick (T)
THN160	Ø60mm	12.5mm
THN180	Ø80mm	12.5mm



DOME Adjustable Floor Glide

- * Nylon base, black, rigid type
- * Stainless steel shell
- * Dimensions of threaded stem to be specified

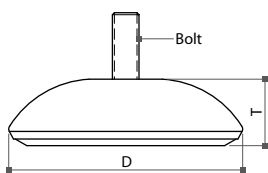

Model No.	Dia. (D)	Thick (T)
DOM170	Ø70.4mm	20mm



11-3 Adjustable Floor Glides

JONES Adjustable Floor Glide

- * PE base, black, white or grey, rigid type
- * Metal shell, nickel or chrome plated
- * Dimensions of threaded stem to be specified

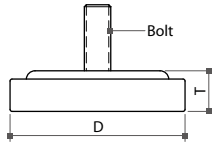

Model No.	Dia. (D)	Thick (T)
JON52	Ø53mm	12.3mm
JON65	Ø65mm	12.3mm

STICK Adjustable Floor Glide

- * PVC base, translucent, rigid type
- * With metal shell cover
- * With M8 threaded stem, length to be specified

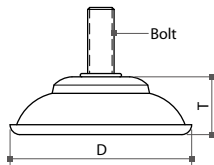

Model No.	Dia. (D)	Thick (T)
STK155	Ø55mm	18.5mm

GEORGIAN Adjustable Floor Glide

- * Plastic base, black or white, rigid or swivel type
- * Metal shell, zinc, chrome, nickel or black plated
- * Dimensions of threaded stem to be specified

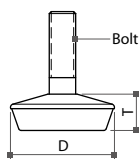

Model No.	Dia. (D)	Thick (T)	Type
GEO41	Ø40.7mm	10.3mm	rigid
GEO131	Ø31.5mm	11.0mm	swivel

11-3 Adjustable Floor Glides

HEX Adjustable Floor Glide

- * Nylon base, black, white, rigid type
- * Without metal shell
- * With hex or round collar
- * Dimensions of threaded stem to be specified

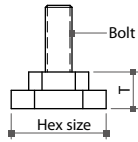

Model No.	Hex size	Thick (T)	Collar
HEX125H	25mm	11mm	hex
HEX125R	25mm	10mm	round

BASE Adjustable Floor Glide

- * Steel base, zinc, rigid type
- * Threaded stems: M8, M10, M12, lengths to be specified

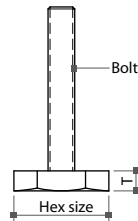

Model No.	Hex size	Thick (T)
BSE25	25mm	6mm

All Metal Adjustable Floor Glide

- * Steel swivel base, zinc plated with plastic cap, Ø32.5mm

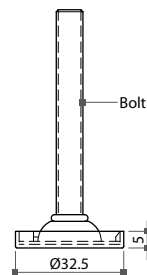

Model No.	Bolt size
UEC870	M8x70mm
UEC890	M8x90mm
UEC1100	M10x100mm

11-3 Adjustable Floor Glides

U-Bracket

- * Steel material zinc plated
- * Bottom hole M8 or M10 threaded, top hole $\text{\O}12.5\text{mm}$
- * With 4 chipboard screw holes
- * To be used with adjustable glide, with bolt top slotted for adjustment by screw driver

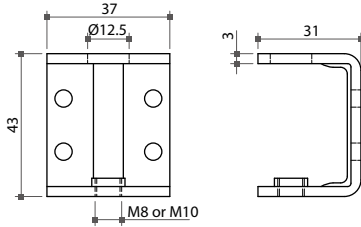

MONTE CARLO, $\text{\O}35\text{mm}$

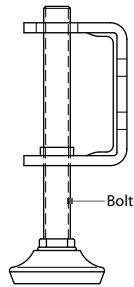

Model No.	Bolt size
UMO890	M8x90mm
UMO1080	M10x80mm
UMO1100	M10x100mm

11-3 Adjustable Floor Glides

LG Plastic Floor Glide

- * Material : plastic
- * Color : black or silver grey coated
- * Top diameter : Ø50mm
- * Threaded stem type, dimensions to be specified

Model No.	D (Ø)	H
LG1500	Ø35mm	43mm
LG1501	Ø30mm	22mm

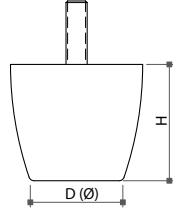

NCG Plastic Floor Glide

- * Material : plastic
- * Color : black or silver grey coated or metallic finishes
- * Stem types : plate, threaded, friction ring and socket

Model No.	D (Ø)	H
NCG301	Ø65mm	50.5mm
NCG302	Ø65mm	61mm
NCG303	Ø70mm	45mm
NCG304	Ø65mm	54.5mm

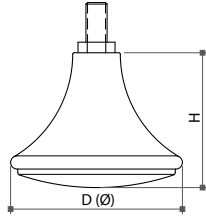

RG20 Plastic Floor Glide

- * Material: plastic
- * Anti-skid, with TPR (rubber) pad at the bottom
- * Stem types : plate, threaded, friction ring and socket

Model No.	D (Ø)	H
RG20	Ø52.5mm	32.5mm

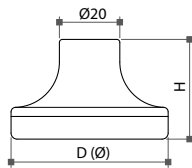

RG38 Plastic Floor Glide

- * Material: plastic
- * Anti-skid, with TPR (rubber) pad at the bottom
- * Stem types : plate, threaded, friction ring and socket

Model No.	D (Ø)	H.
RG38	Ø52.5mm	32.5mm

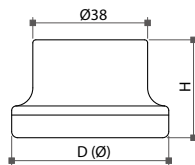

11-3 Adjustable Floor Glides

BDG Series Bed Glide

- * Glide: nylon
- * Plastic leg: polypropylene (PP)
- * All black or gray (special color, available upon request)

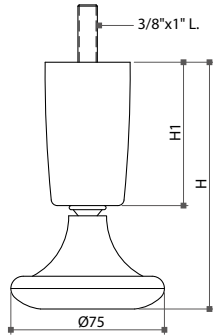

Model No.	H1	H
BDG-75	22mm	71.5mm
BDG-100	45mm	94mm
BDG-125	70mm	120.5mm
BDG-150	90mm	139.5mm

BDC Series Bed Castor

- * Plastic leg in polypropylene (PP) with nylon twin wheel castor (unhooded)
- * All black or gray (special color, available upon request)

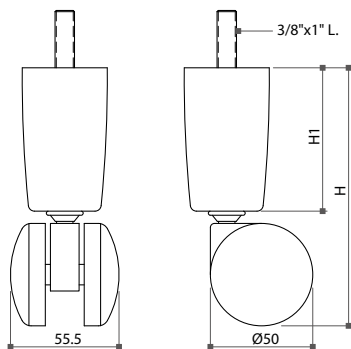

Model No.	H1	H
BDC-75	22mm	77.5mm
BDC-100	45mm	99mm
BDC-125	70mm	126mm
BDC-150	90mm	145mm

11-4 Nail Glides & Bumpers

5381 Nail Glide, Flat Type

- * PE material, white, black, brown, beige or gray
- * Nail size : Ø1.8x18mm L.

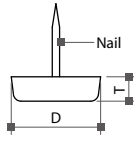

Item No.	Dia. (D)	Thick (T)
53811	Ø9.5mm (3/8")	3.8mm
53812	Ø12mm (1/2")	4.0mm
53813	Ø15mm (5/8")	5.5mm
53814	Ø18mm (3/4")	6.0mm
53815	Ø21mm (7/8")	6.0mm
53816	Ø24mm (1")	6.0mm
53817	Ø27mm (1-1/16")	6.0mm



5382 Nail Glide, Convex Type

- * PE material, white, black, brown, beige or gray
- * Nail size : Ø1.8x18mm L.

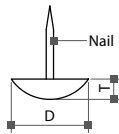

Item No.	Dia. (D)	Thick (T)
53822	Ø16mm (5/8")	4.5mm
53823	Ø18mm (3/4")	4.5mm
53824	Ø21mm (7/8")	4.5mm



5391 Nail Glide, Semicircle Type

- * PE material, white, black, brown, beige or gray
- * Nail size : Ø1.8x18mm L.

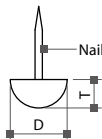

Item No.	Dia. (D)	Thick (T)
53910	Ø9.5mm (3/8")	5.5mm
53911	Ø12mm (1/2")	6.0mm
53912	Ø14mm (9/16")	7.0mm
53913	Ø16mm (5/8")	8.0mm
53914	Ø18mm (3/4")	9.0mm



11-4 Nail Glides & Bumpers

5384 Nail Glide

- * Plastic material, white, black or brown
- * Base with felt
- * Nail size : $\varnothing 2.0 \times 17 \text{mm L}$.

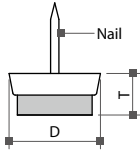

Item No.	Dia. (D)	Thick (T)
53841	$\varnothing 16 \text{mm}$ (5/8")	10mm
53842	$\varnothing 19 \text{mm}$ (3/4")	10mm
53843	$\varnothing 22 \text{mm}$ (7/8")	10mm
53844	$\varnothing 25 \text{mm}$ (1")	10mm
53847	$\varnothing 28 \text{mm}$ (1-1/8")	10mm

5383 Nail Glide

- * Material : PVC, with rubber pad
- * Color : white / black
- * Nail size : $\varnothing 2.6 \times 20 \text{mm L}$. or $\varnothing 1.8 \times 12 \text{mm L}$.

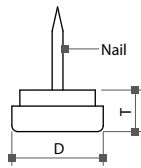

Item No.	Dia. (D)	Thick (T)
53833	$\varnothing 15 \text{mm}$ (5/8")	10mm
53834	$\varnothing 18 \text{mm}$ (3/4")	10mm
53835	$\varnothing 21 \text{mm}$ (7/8")	10mm
53837	$\varnothing 27 \text{mm}$ (1-1/16")	10mm

5380 Nail Glide

- * Material : PVC, with metal boot
- * Color : black
- * Metal boot, nickel or chrome plated
- * Nail size : $\varnothing 2.7 \times 18 \text{mm L}$.

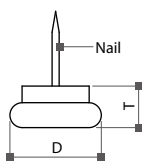

Item No.	Dia. (D)	Thick (T)
53805	$\varnothing 22 \text{mm}$ (7/8")	10mm
53807	$\varnothing 27 \text{mm}$ (1-1/16")	10mm

11-4 Nail Glides & Bumpers

5388 Nail Glide, Rectangle type

* PE material, white, black, brown, beige or gray

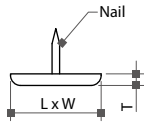

Item No.	Size (LxW)	Thick (T)	Nail size
53880	12.7x18mm (1/2"x3/4")	2.0mm	Ø1.6x9mm L.
53882	12.6x30.5mm (1/2"x1-1/4")	2.3mm	Ø1.5x10mm L.
53883	17.6x12.3mm (11/16"x1/2")	2.3mm	Ø1.6x9mm L.

5386 Nail Glide, Ellipse type

* PE material, white, black, brown, beige or gray

* Double pin

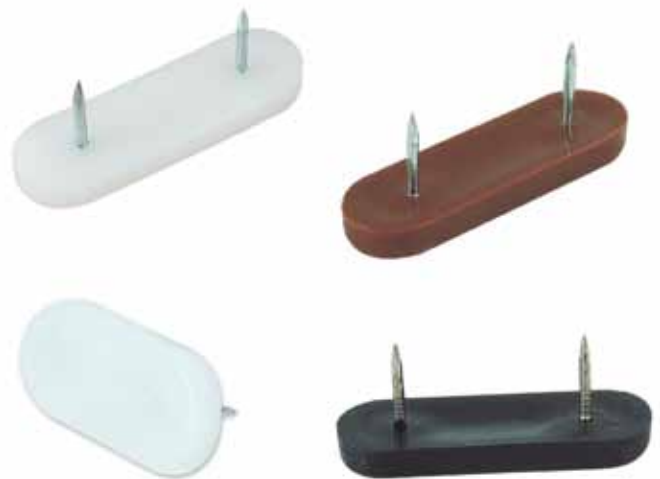
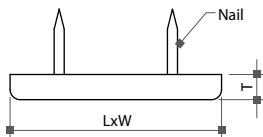

Item No.	Size (LxW)	Thick (T)	Nail size
53866	42x19mm (1-5/8"x3/4")	5.0mm	Ø2x13mm L.
53867	49x15mm (1-15/16"x5/8")	6.0mm	Ø1.75x14mm L.

11-4 Nail Glides & Bumpers

Self Adhesive Bumper

- * Easy peeling-off and convenient adhesion
- * Material: PU (polyurethane) in clear, silicon in translucent or rubber in black, grey or brown
- * Ideal for door, furniture legs and stands, to prevent slamming, slipping and scratching
- * Other specifications are available
- * Provided in sheets



Cylindrical Type

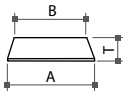

Item No.	A	B	T	Quantity (pieces/sheet)	Material
85122	Ø12.7mm	Ø10.0mm	3.5mm	100 pcs	PU, silicon or rubber
85123	Ø13.3mm	Ø13.3mm	4.2mm	64 pcs	PU, silicon or rubber
85124	Ø11.6mm	Ø7.0mm	4.2mm	100 pcs	rubber

Semispherical Type

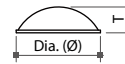

Item No.	Dia.	T	Quantity (pieces/sheet)	Material
85131	Ø8mm	2.5mm	100 pcs	PU, silicon or rubber
85132	Ø10mm	4.0mm	100 pcs	
85133	Ø11mm	5.5mm	64 pcs	
85134	Ø15.7mm	7.8mm	64 pcs	
85135	Ø17.9mm	9.2mm	36 pcs	

Square Type

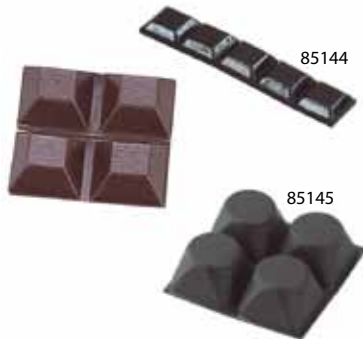

Item No.	SxS	T	Quantity (pieces/sheet)	Material
85140	10.2x10.2mm	2.5mm	64 pcs	silicon or rubber
85141	12.5x12.5mm	6.0mm	64 pcs	
85142	12x12mm	3.5mm	64 pcs	
85143	20x20mm	7.8mm	64 pcs	PU
85144	8.3x8.3mm	2.6mm	144 pcs	
*85145	19.5x19.5mm	12.3mm	64 pcs	PU or rubber

* 85145 with round top

Convex Type

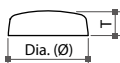

Item No.	Dia.	T	Quantity (pieces/sheet)	Material
85170	Ø9.6mm	3.8mm	64 pcs	PU, silicon or rubber
85171	Ø11mm	5mm	64 pcs	

Recessed-1 Type

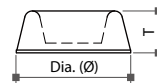

Item No.	Dia.	T	Quantity (pieces/sheet)	Material
85150	Ø20mm	10.0mm	180 pcs	rubber
85151	Ø22mm	10.3mm	36 pcs	PU, silicon or rubber

Recessed-2 Type

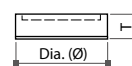

Item No.	Dia.	T	Quantity (pieces/sheet)	Material
85161	Ø15mm	4.0mm	64 pcs	rubber

Алматы (7273)495-231
Ангарск (3955)60-70-56
Архангельск (8182)63-90-72
Астрахань (8512)99-46-04
Барнаул (3852)73-04-60
Белгород (4722)40-23-64
Благовещенск (4162)22-76-07
Брянск (4832)59-03-52
Владивосток (423)249-28-31
Владикавказ (8672)28-90-48
Владимир (4922)49-43-18
Волгоград (844)278-03-48
Вологда (8172)26-41-59
Воронеж (473)204-51-73
Екатеринбург (343)384-55-89

Иваново (4932)77-34-06
Ижевск (3412)26-03-58
Иркутск (395)279-98-46
Казань (843)206-01-48
Калининград (4012)72-03-81
Калуга (4842)92-23-67
Кемерово (3842)65-04-62
Киров (8332)68-02-04
Коломна (4966)23-41-49
Кострома (4942)77-07-48
Краснодар (861)203-40-90
Красноярск (391)204-63-61
Курск (4712)77-13-04
Курган (3522)50-90-47
Липецк (4742)52-20-81

Магнитогорск (3519)55-03-13
Москва (495)268-04-70
Мурманск (8152)59-64-93
Набережные Челны (8552)20-53-41
Нижний Новгород (831)429-08-12
Новокузнецк (3843)20-46-81
Ноябрьск (3496)41-32-12
Новосибирск (383)227-86-73
Омск (3812)21-46-40
Орел (4862)44-53-42
Оренбург (3532)37-68-04
Пенза (8412)22-31-16
Петрозаводск (8142)55-98-37
Псков (8112)59-10-37

Пермь (342)205-81-47
Ростов-на-Дону (863)308-18-15
Рязань (4912)46-61-64
Самара (846)206-03-16
Саранск (8342)22-96-24
Санкт-Петербург (812)309-46-40
Саратов (845)249-38-78
Севастополь (8692)22-31-93
Симферополь (3652)67-13-56
Смоленск (4812)29-41-54
Сочи (862)225-72-31
Ставрополь (8652)20-65-13
Сургут (3462)77-98-35
Сыктывкар (8212)25-95-17
Тамбов (4752)50-40-97

Тверь (4822)63-31-35
Тольятти (8482)63-91-07
Томск (3822)98-41-53
Тула (4872)33-79-87
Тюмень (3452)66-21-18
Ульяновск (8422)24-23-59
Улан-Удэ (3012)59-97-51
Уфа (347)229-48-12
Хабаровск (4212)92-98-04
Чебоксары (8352)28-53-07
Челябинск (351)202-03-61
Череповец (8202)49-02-64
Чита (3022)38-34-83
Якутск (4112)23-90-97
Ярославль (4852)69-52-93

Россия +7(495)268-04-70

Казахстан +7(7172)727-132

Киргизия +996(312)96-26-47

www.fourwinds.nt-rt.ru | | fse@nt-rt.ru