

Алматы (7273)495-231	Иваново (4932)77-34-06	Магнитогорск (3519)55-03-13	Пермь (342)205-81-47	Тверь (4822)63-31-35
Ангарск (3955)60-70-56	Ижевск (3412)26-03-58	Москва (495)268-04-70	Ростов-на-Дону (863)308-18-15	Тольятти (8482)63-91-07
Архангельск (8182)63-90-72	Иркутск (395)279-98-46	Мурманск (8152)59-64-93	Рязань (4912)46-61-64	Томск (3822)98-41-53
Астрахань (8512)99-46-04	Казань (843)206-01-48	Набережные Челны (8552)20-53-41	Самара (846)206-03-16	Тула (4872)33-79-87
Барнаул (3852)73-04-60	Калининград (4012)72-03-81	Нижний Новгород (831)429-08-12	Саранск (8342)22-96-24	Тюмень (3452)66-21-18
Белгород (4722)40-23-64	Калуга (4842)92-23-67	Новокузнецк (3843)20-46-81	Санкт-Петербург (812)309-46-40	Ульяновск (8422)24-23-59
Благовещенск (4162)22-76-07	Кемерово (3842)65-04-62	Ноябрьск (3496)41-32-12	Саратов (845)249-38-78	Улан-Удэ (3012)59-97-51
Брянск (4832)59-03-52	Киров (8332)68-02-04	Новосибирск (383)227-86-73	Севастополь (8692)22-31-93	Уфа (347)229-48-12
Владивосток (423)249-28-31	Коломна (4966)23-41-49	Омск (3812)21-46-40	Симферополь (3652)67-13-56	Хабаровск (4212)92-98-04
Владикавказ (8672)28-90-48	Кострома (4942)77-07-48	Орел (4862)44-53-42	Смоленск (4812)29-41-54	Чебоксары (8352)28-53-07
Владимир (4922)49-43-18	Краснодар (861)203-40-90	Оренбург (3532)37-68-04	Сочи (862)225-72-31	Челябинск (351)202-03-61
Волгоград (844)278-03-48	Красноярск (391)204-63-61	Пенза (8412)22-31-16	Ставрополь (8652)20-65-13	Череповец (8202)49-02-64
Вологда (8172)26-41-59	Курск (4712)77-13-04	Петрозаводск (8142)55-98-37	Сургут (3462)77-98-35	Чита (3022)38-34-83
Воронеж (473)204-51-73	Курган (3522)50-90-47	Псков (8112)59-10-37	Сыктывкар (8212)25-95-17	Якутск (4112)23-90-97
Екатеринбург (343)384-55-89	Липецк (4742)52-20-81		Тамбов (4752)50-40-97	Ярославль (4852)69-52-93

Россия +7(495)268-04-70

Казахстан +7(7172)727-132

Киргизия +996(312)96-26-47

www.fourwinds.nt-rt.ru | fse@nt-rt.ru

Технические характеристики на акустические панели компании **Four Winds**

Виды товаров: акустические панели для отдельно стоящих столов, настольные перегородки, шумоизоляционные панели для пола и стен, перегородки напольные, акустической басовой ловушки, аксессуары, светодиодные светильники, ножки экрана и др.

Eco Sound Acoustic Panels & Products

Colors 顏色選擇

• 9mm thickness



03 silver

18 light gray

04 ash

• 12mm thickness



01 navy

05 light blue

11 yellow

22 taupe

03 silver

06 orange

12 lime

24 white

04 ash

09 black

18 light gray

25 red

Features 特性介紹

Noise Reduction

The acoustic panel has been tested by SGS and received an NRC (noise reduction coefficient) result of 0.85 meaning 85% of noise is absorbed.

聚酯纖維吸音板的減噪係數 (NRC) 達 0.85，即可吸收約 85% 的迴音，以降低噪音。



Flame Retardant

The acoustic panel is ranked GB8624-2012 B1 (B-S2.d0.t1) classification. 防焰達到 B-S2.d0.t1 等級 (GB8624-2012 規格), 通過台灣防焰性能試驗。



Eco-Friendly

The acoustic panels are made of polyester (PET) fiber, single material and 100% recyclable.

Eco Sound 吸音板由聚酯纖維製成，單一材質，可 100% 回收，具備環保特性。



Eco Sound Acoustic Panels & Products

Eco Sound PET acoustic panel with CUBE18 frame

1) Table partition page 4 ~ 10



2) Floor partition page 11 ~ 18



4) Acoustic privacy cube page 19

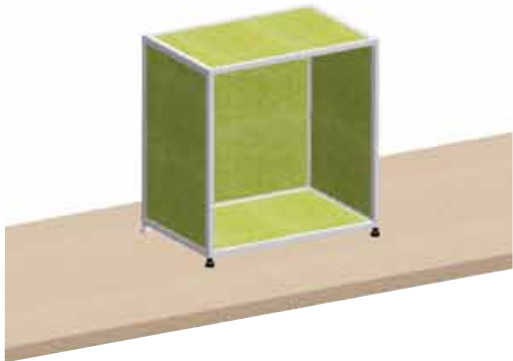

5) Wall-mounted acoustic partition page 20 ~ 23



Eco Sound Acoustic Panels & Products

DM35 Desk Top Partition

- * 2-layer acoustic panels (18mm overall thickness), uni-color or dual colors
兩片 9mm 厚吸音板合併成 18mm 厚, 可為單一顏色或雙色搭配
- * To be mounted against desk top, with screws
- * Height: 350mm

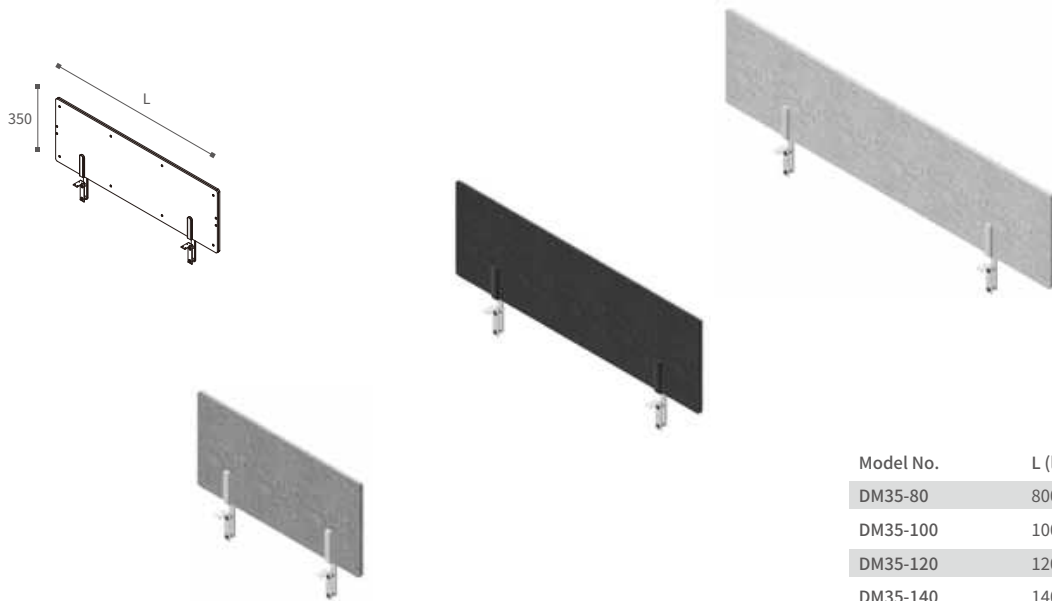

Model No.	L (length)
DM35-80	800mm
DM35-100	1000mm
DM35-120	1200mm
DM35-140	1400mm



Eco Sound Acoustic Panels & Products

Desk Top Framed Partition

*To be mounted on wooden table top with screws

*Acoustic panel thickness 12mm

SQ-DM40

Desk Top Mono-Framed Partition

*Height: 400mm

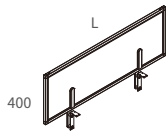

Model No.	Length (L)
SQ-DM4080	800mm
SQ-DM40100	1000mm
SQ-DM40120	1200mm



SQ-2DM40

Desk Top Dual-Framed Partition

*Height: 400mm

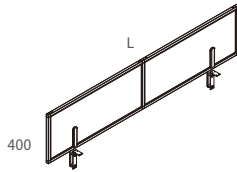

Model No.	Length (L)
SQ-2DM40140	1382 (700 + 682)mm
SQ-2DM40160	1582 (800 + 782)mm
SQ-2DM40180	1782 (900 + 882)mm



SQ-DM40-DL

Desk Top Mono-Framed Partition
ready for DL18 LED Linear Light

*Height: 532mm

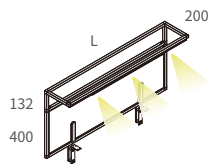

Model No.	Length (L)
SQ-DM4080-DL	800mm
SQ-DM40100-DL	1000mm
SQ-DM40120-DL	1200mm



SQ-2DM40-DL

Desk Top Dual-Framed Partition
ready for DL18 LED Linear Light

*Height: 532mm

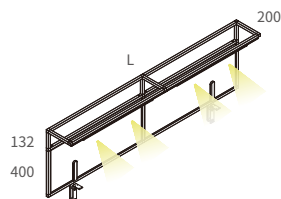

Model No.	Length (L)
SQ-2DM40140-DL	1382 (700 + 682)mm
SQ-2DM40160-DL	1582 (800 + 782)mm
SQ-2DM40180-DL	1782 (900 + 882)mm



Eco Sound Acoustic Panels & Products

DM70 Desk Top Partition

- * 2-layer acoustic panels (18mm overall thickness), uni-color or dual colors
兩片 9mm 厚吸音板併成 18mm 厚, 可為單一顏色或雙色搭配
- * To be mounted against desk top, with screws
- * Height: 700mm

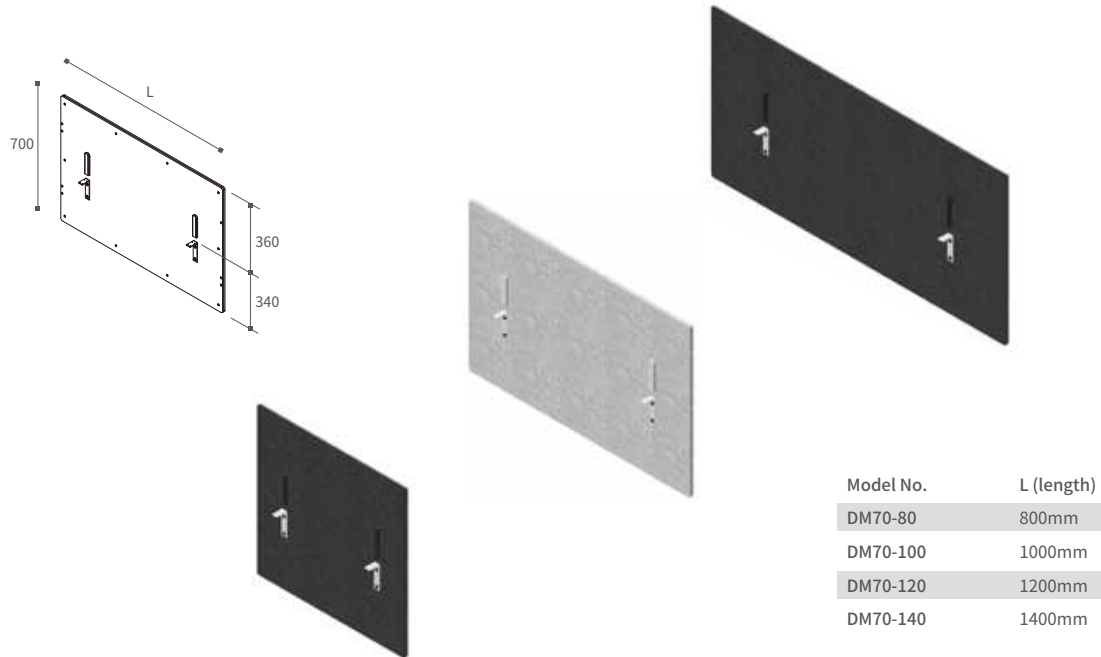

Eco Sound Acoustic Panels & Products

Desk Top Framed Partition

*To be mounted on wooden table top with screws

*Acoustic panel thickness 12mm

*Height: 782mm

SQ-DM80

2-Level Desk Top Mono-Framed Partition

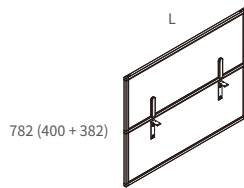

Model No.	Length (L)
SQ-DM8080	800mm
SQ-DM80100	1000mm
SQ-DM80120	1200mm



SQ-2DM80

2-Level Desk Top Dual-Framed Partition

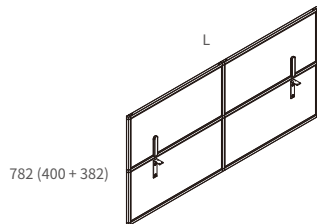

Model No.	Length (L)
SQ-2DM80140	1382 (700 + 682)mm
SQ-2DM80160	1582 (800 + 782)mm
SQ-2DM80180	1782 (900 + 882)mm



Eco Sound Acoustic Panels & Products

Desk Top Framed Partition ready for DL18 LED Linear Light

- * To be mounted on wooden table top with screws
- * Acoustic panel thickness 12mm

SQ-DM80-DL
2-Level Desk Top Mono-Framed Partition
* Height: 914mm

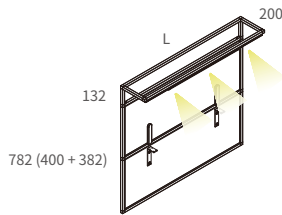

Model No.	Length (L)
SQ-DM8080-DL	800mm
SQ-DM80100-DL	1000mm
SQ-DM80120-DL	1200mm



SQ-DM80-DL
2-Level Desk Top Dual-Framed Partition
* Height: 914mm

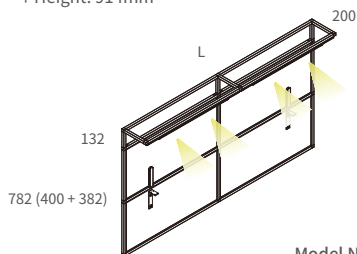

Model No.	Length (L)
SQ-2DM80140-DL	1382 (700 + 682)mm
SQ-2DM80160-DL	1582 (800 + 782)mm
SQ-2DM80180-DL	1782 (900 + 882)mm



DL18 LED Linear Light, 24 Vdc
DL18-2L-30K 3000 K / 600 lm
DL18-2L-57K 5700 K / 660 lm
* Dimension: 18.3 x 18.3mm
* 8.6 watts

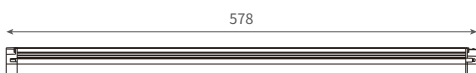

Eco Sound Acoustic Panels & Products

Table Top Partition Stand

- * Movable with aluminium fixing stand or fixed with 3M tape
- * Acoustic panel thickness 12mm



DST3560
* Size: (W) 600 x (H) 356mm

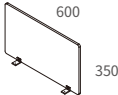

DST3580
* Size: (W) 800 x (H) 356mm

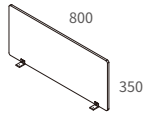

DST35100
* Size: (W) 1000 x (H) 356mm

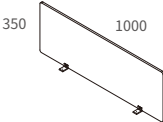

DST35120
* Size: (W) 1200 x (H) 356mm

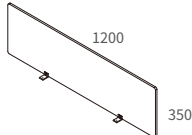

Eco Sound Acoustic Panels & Products

Freestanding Framed Table Partition

*Acoustic panel thickness 12mm
*Height: 376mm

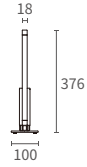

SQ-TST35
Freestanding Mono-Framed Table Partition

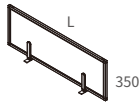
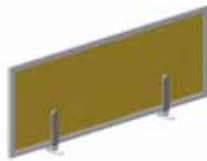

Model No.	Length (L)
SQ-TST3580	800mm
SQ-TST35100	1000mm
SQ-TST35120	1200mm

Freestanding Framed Table Partition

Ready for DL18 LED Linear Light
*Acoustic panel thickness 12mm
*Height: 376mm

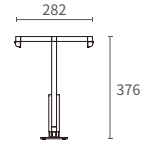

SQ-TST35-DL
Freestanding Mono-Framed Table Partition

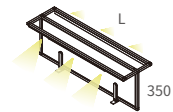

Model No.	Length (L)
SQ-TST3580-DL	800mm
SQ-TST35100-DL	1000mm
SQ-TST35120-DL	1200mm

SQ-2TST35

Freestanding Dual-Framed Table Partition

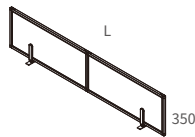
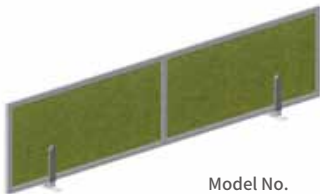

Model No.	Length (L)
SQ-2TST35140	1382 (700 + 682)mm
SQ-2TST35160	1582 (800 + 782)mm
SQ-2TST35180	1782 (900 + 882)mm

SQ-2TST35-DL

Freestanding Dual-Framed Table Partition

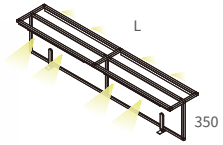

Model No.	Length (L)
SQ-2TST35140-DL	1382 (700 + 682)mm
SQ-2TST35160-DL	1582 (800 + 782)mm
SQ-2TST35180-DL	1782 (900 + 882)mm



Eco Sound Acoustic Panels & Products

Floorstanding Table Partition

* For table leg 710mm H. & desk tops 700 x 1400, 800 x 1600 & 900 x 1800mm

* Acoustic panel thickness 12mm

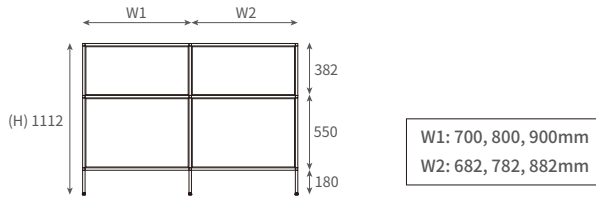

I) *Frame-L*

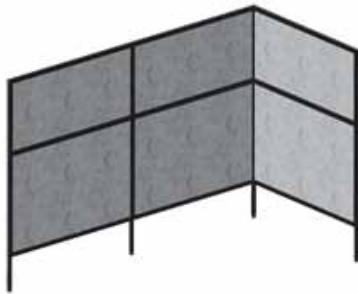
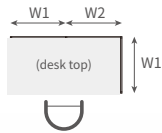

II) *Frame-L-DL18*

* With DL18 LED linear light

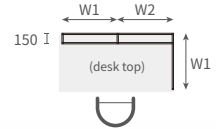

III) *Frame-T*

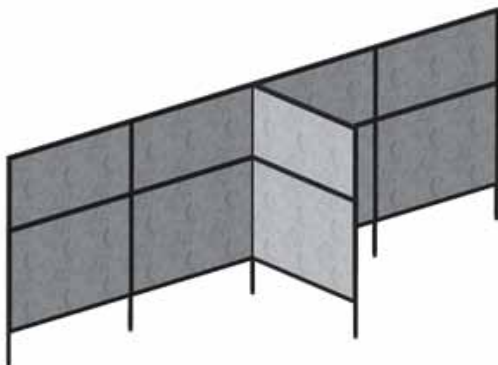
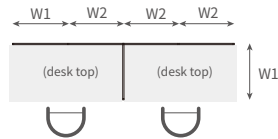

IV) *Frame-T-DL18*

* With DL18 LED linear light

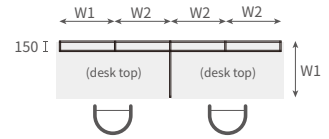

Eco Sound Acoustic Panels & Products

Co-Constructed Partition with Table Frame

- * For inset or overlay table top
- * Acoustic panel thickness 12mm

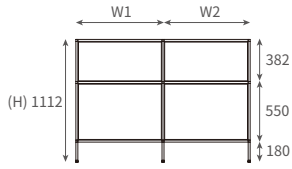

W1: 700 & 800mm
W2: 682 & 782mm

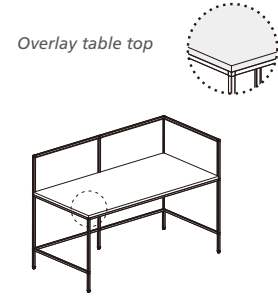
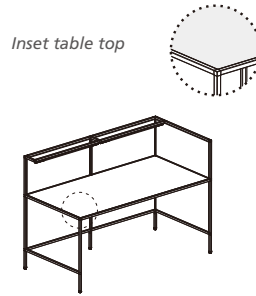

I) CUBE18-L

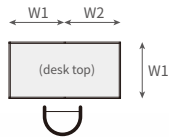

II) CUBE18-L-DL18

* With DL18 LED linear light

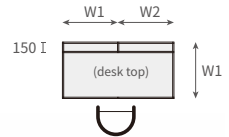

III) CUBE18-T

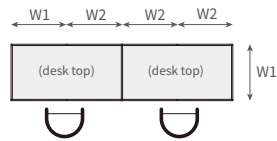

IV) CUBE18-T-DL18

* With DL18 LED linear light

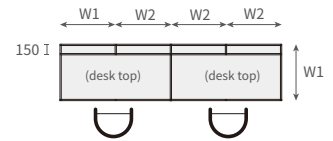

Eco Sound Acoustic Panels & Products

Floorstanding Table Partition

* Especially suitable for sit-to-stand desk with desk top 700 x 1400, 800 x 1600 & 900 x 1800mm

* Acoustic panel thickness 12mm

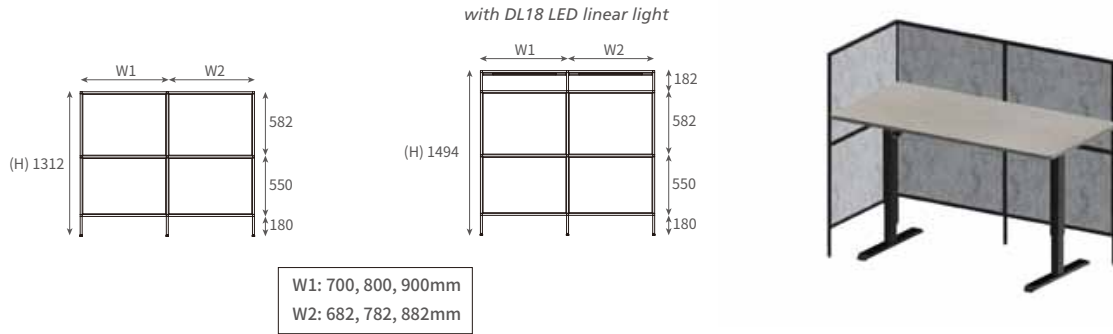

I) ELT-L

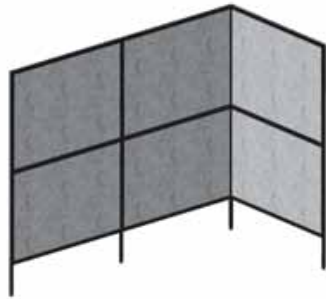
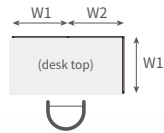

II) ELT-L-DL18

* With DL18 LED linear light

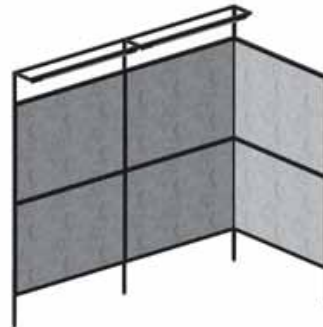
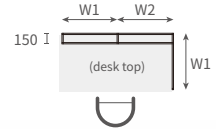

III) ELT-T

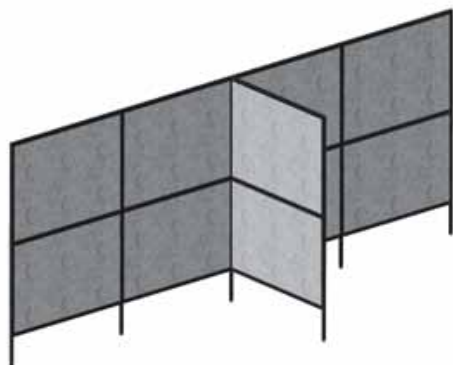
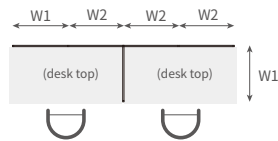

IV) ELT-T-DL18

* With DL18 LED linear light

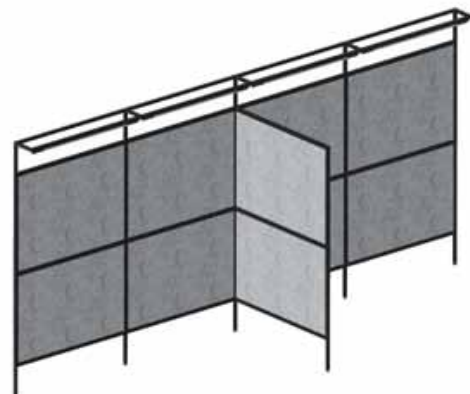
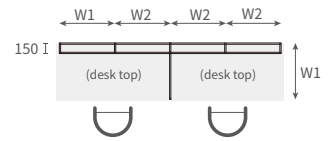

Eco Sound Acoustic Panels & Products

Stand Legs & Folding Hinges for CUBE18 Screen

AFS18-GL56 Screen Floor Stand
 *With GL56 (Ø56 x 20mm) heavy steel glides
 *Matt black (NK)

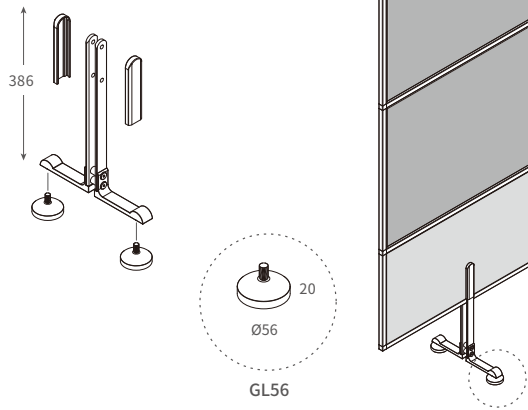

AFS18-AFD75 Screen Floor Stand
 *With AFD75 (Ø75 mm) aluminium castors, with brakes
 *Matt silver (NA)

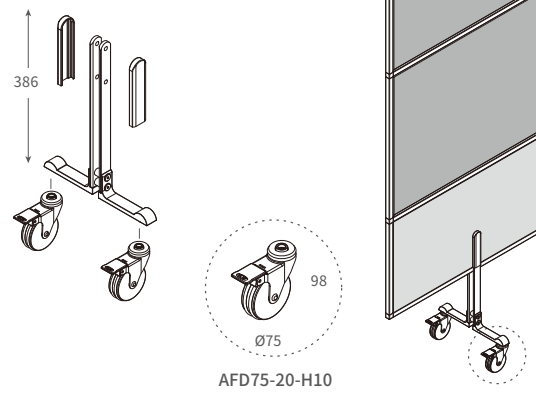

HBF197-AL Screen Feet
 *With AL32 height adjustable glide
 *Height: 197mm

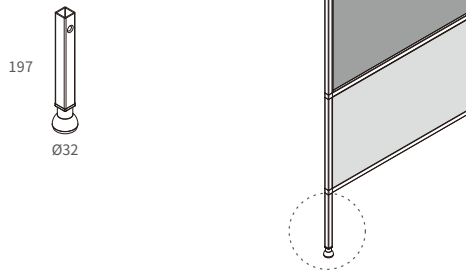

HBF218-SKA35 Screen Feet
 *With SKA35 (ø35mm) castor, with brake
 *Height: 218mm

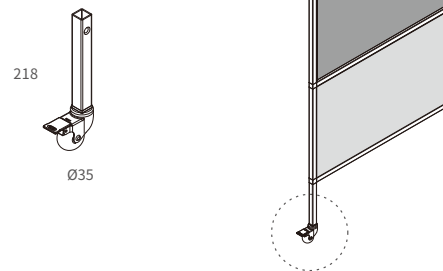

HBF230 Screen Feet
 *With CHA222 height adjustable glide
 *Height: 230mm

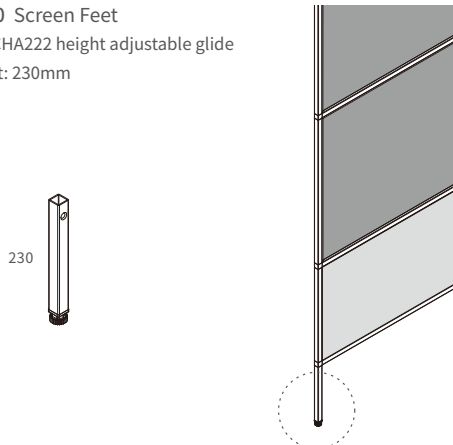

20861 Folding Screen Hinge
 *Dimensions: (L) 44.7 x (W) 23mm
 *Steel in black

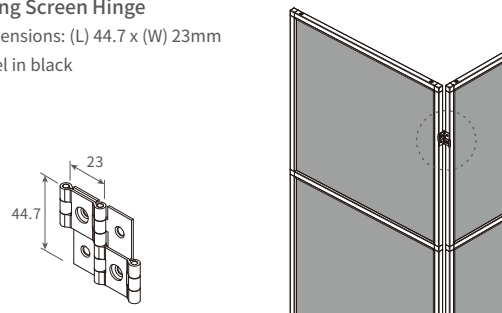

Eco Sound Acoustic Panels & Products

SQ-HBF Vertical Floor Partition

- *With HBF197-AL (H=1761), HBF218-SKA35 (H=1782) or HBF230 (H=1794) screen feet
- *Acoustic panel thickness 12mm

SQ-HBF179 Mono-Framed Floor Partition

- *With HBF230 screen feet
- *Height: 1794mm

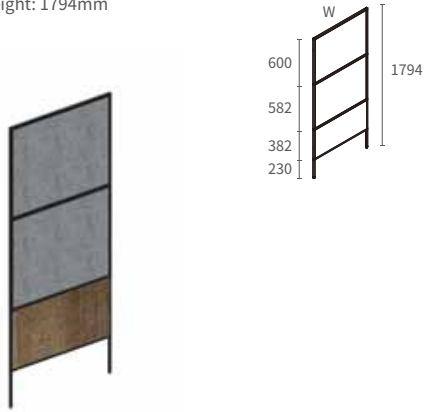

Model No.	Width (W)
SQ-HBF179-60	600mm
SQ-HBF179-80	800mm

SQ-2HBF179 Dual-Framed Floor Partition

- *With HBF230 screen feet
- *Height: 1794mm

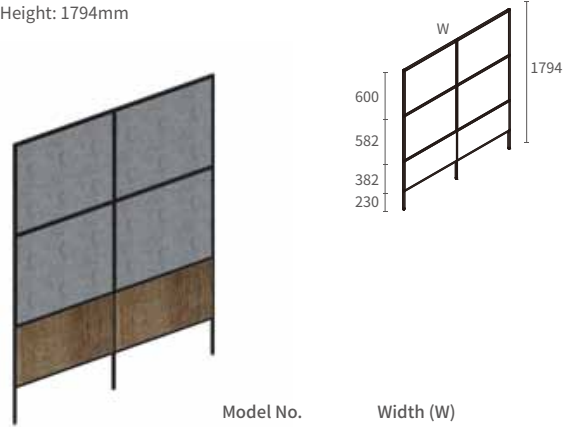

Model No.	Width (W)
SQ-2HBF179-140	1382 (700 + 682)mm
SQ-2HBF179-160	1582 (800 + 782)mm
SQ-2HBF179-180	1782 (900 + 882)mm

SQ-2HBF179

L Framed Folding Floor Partition

- *With HBF230 screen feet
- *Height: 1794mm

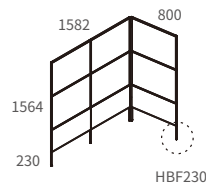

SQ-3HBF-SKA35

Z Framed Folding Floor Partition

- *With HBF218-SKA35 screen feet
- *Height: 1782mm

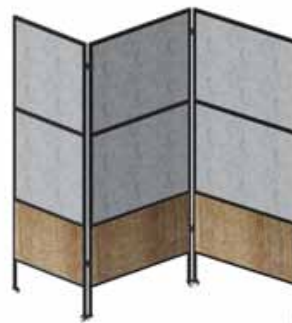
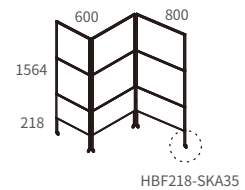

Eco Sound Acoustic Panels & Products

SQ-FST Vertical Floor Partition

- *With AFS18-SGL screen floor stand, not including adjustable glides or castors
- *Acoustic panel thickness 12mm
- *Height: 1819mm

SQ-FST181 Mono-Framed Floor Partition

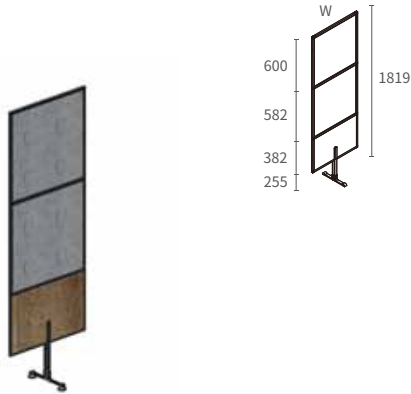

Model No.	Width (W)
SQ-FST181-60	600mm
SQ-FST181-80	800mm

SQ-2FST181 Dual-Framed Floor Partition

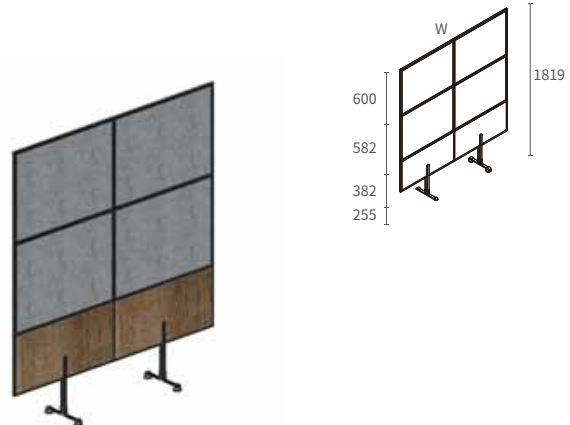

Model No.	Width (W)
SQ-2FST181-140	1382 (700 + 682)mm
SQ-2FST181-160	1582 (800 + 782)mm
SQ-2FST181-180	1782 (900 + 882)mm

SQ-3FST181-GL Z Framed Folding Floor Partition

- *With GL56 (Ø56 x 20mm) glides
- *Height: 1839mm

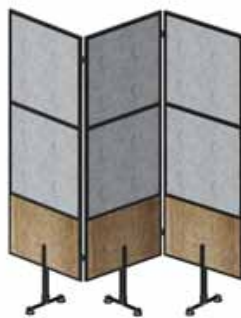
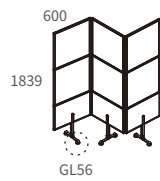

SQ-2FST181-GL V Framed Folding Floor Partition

- *With GL56 (Ø56 x 20mm) glides
- *Height: 1839mm

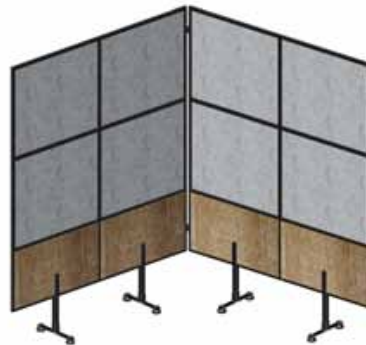
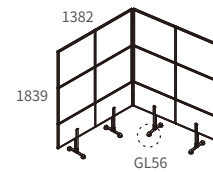

Eco Sound Acoustic Panels & Products

SQ-HST Horizontal Floor Partition

- *Width (W)= 1000 & 1200mm
- *Acoustic panel thickness 12mm

SQ-HST-TP40 Height= 400mm
 SQ-HST-TP50 Height= 500mm
 Partition Top Panel

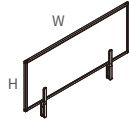

SQ-HST-LK40 Height= 400mm
 SQ-HST-LK50 Height= 500mm
 Partition Middle Panel

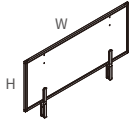

SQ-HST-BT40 Height= 400mm
 SQ-HST-BT50 Height= 500mm
 Partition Bottom Panel
 *With laminated chipboard (18mm T.)
 and AFS18-SGL screen floor stand

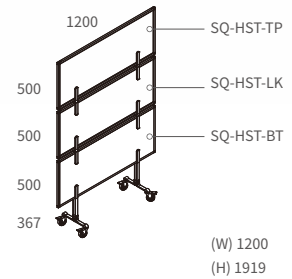
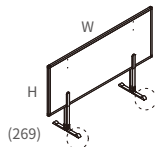

Eco Sound Acoustic Panels & Products

SQ-2HST Horizontal Floor Partition

- *Width (W)= 1382 (700 + 682), 1582 (800 + 782) or 1782 (900 + 882)mm
- *Acoustic panel thickness 12mm

SQ-2HST-TP40 Height= 400mm
 SQ-2HST-TP50 Height= 500mm
 Partition Top Panel

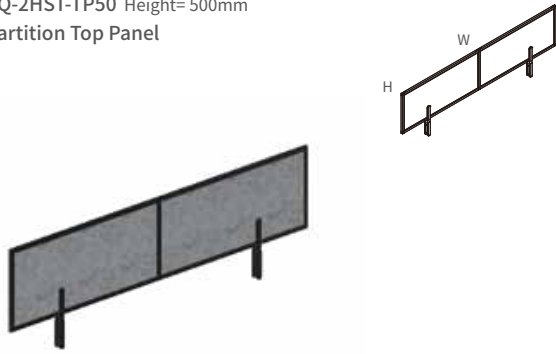

SQ-2HST-LK40 Height= 400mm
 SQ-2HST-LK50 Height= 500mm
 Partition Middle Panel

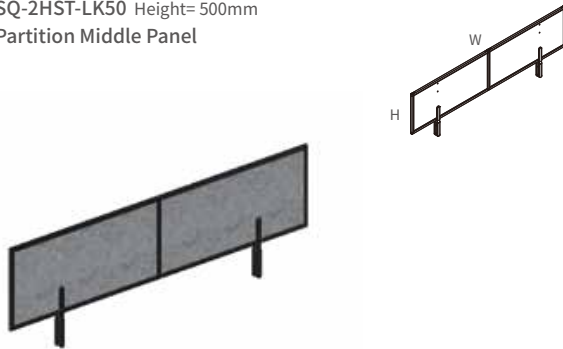

SQ-2HST-BT40 Height= 400mm
 SQ-2HST-BT50 Height= 500mm
 Partition Bottom Panel

- *With laminated chipboard (18mm T.)
- and AFS18-SGL screen floor stand

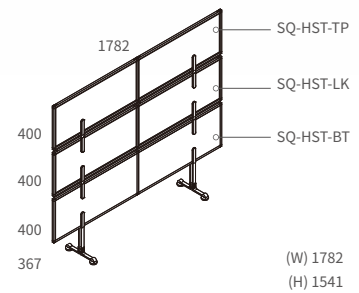

Eco Sound Acoustic Panels & Products

CUBE18 Privacy Acoustic Station 降噪個人工作站

*Acoustic panel thickness 12mm

1) CUBE18 Privacy Acoustic Station 個人降音工作站



(W) 800
(D) 1032
(H) 1494

Privacy station with Eco Sound acoustic panelled partition helps reducing environmental noise
三面吸音板隔屏工作站, 可降低環境噪音

2) Standing Acoustic Cube 站立型降噪箱



(W) 600
(D) 400
(H) 1658

3) Desk Top Acoustic Cube 桌上型降噪箱



(W) 600
(D) 400
(H) 629

4) 5-Face Acoustic Cube 三合一降噪箱



Model No.	Dimensions (L x D x H)
5F-5050-50	500 x 500 x 500mm
5F-4040-40	400 x 400 x 400mm
5F-3030-30	300 x 300 x 300mm

Eco Sound Acoustic Panels & Products

ACD60120P

Wall-Mounted Acoustic Cube Divider

*Dimensions: (L) 120 x (D) 600 x (H) 1200mm

*Acoustic panel thickness 12mm

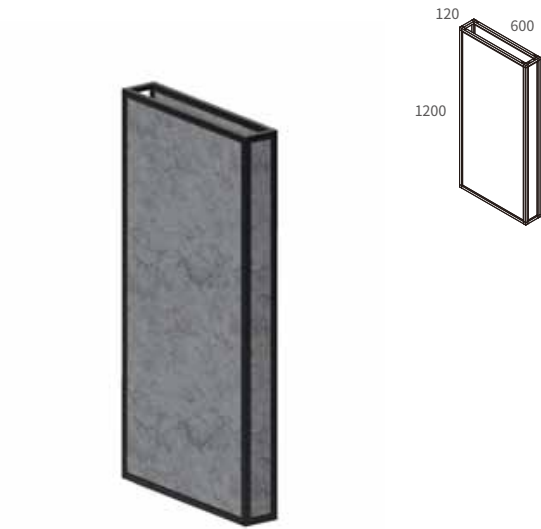

ABX3550P

Wall-Mounted Acoustic Box

*Dimensions: (L) 500 x (D) 350 x (H) 500mm

*Acoustic panel thickness 12mm

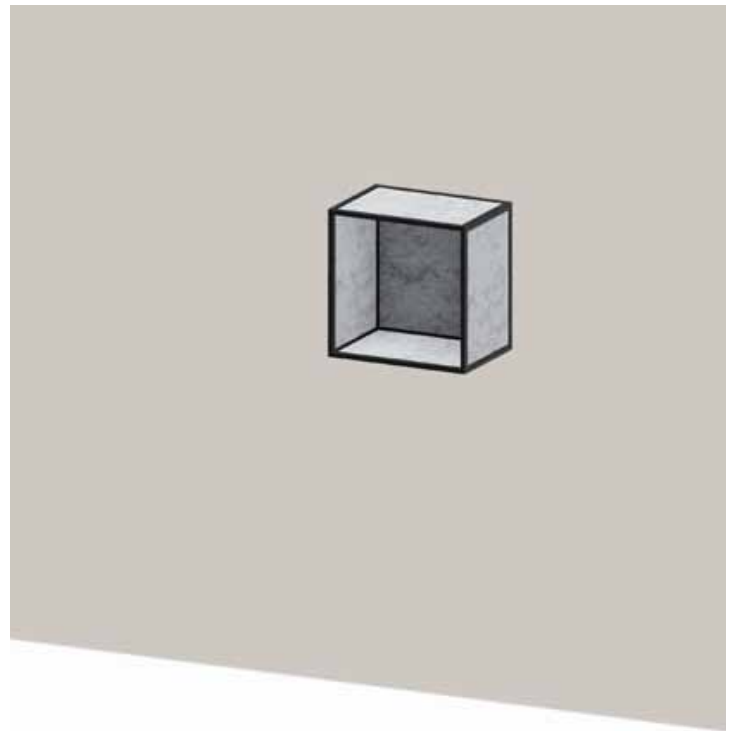
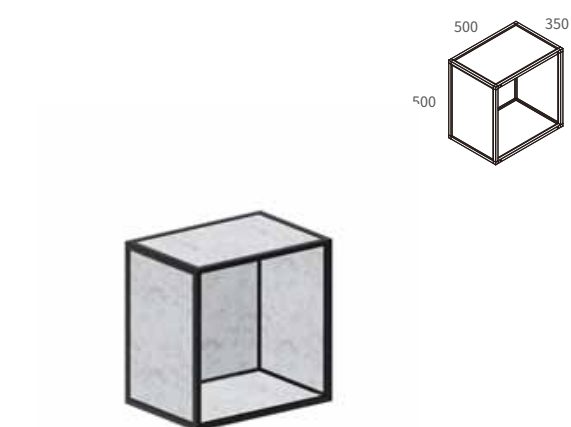

Eco Sound Acoustic Panels & Products

Wall-mounted acoustic cube frame

*Acoustic panel thickness 12mm

1-Tier Acoustic Cube Side Frame
 ACF1540SP-L Left side
 ACF1540SP-R Right side
 *Dimensions: (D) 150 x (H) 400mm
 *With keyhole

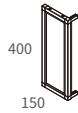

ACF1540SP-L
(left side)



ACF1540SP-R
(right side)

ACF40FP-11
 1-Tier Acoustic Face Frame
 *Height: 400mm

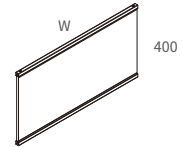

Model No.	Length (L)
ACF4040FP-11	364mm
ACF4060FP-11	564mm
ACF4080FP-11	764mm

ACF40FP-12
 1-Tier Acoustic Dual Face Frame
 *Height: 400mm

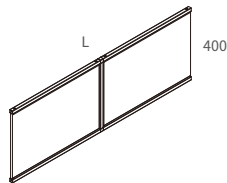

Model No.	Length (L)
ACF4080FP-12	746 (382 + 364)mm
ACF40120FP-12	1146 (582 + 564)mm

2-Tier Acoustic Cube Side Frame
 2ACF1580SP-L Left side
 2ACF1580SP-R Right side
 *Dimensions: (D) 150 x (H) 782mm
 *With keyhole



2ACF1580SP-L
(left side)



2ACF1580SP-R
(right side)

2ACF80FP-21
 2-Tier Acoustic Face Frame
 *Height: 782mm

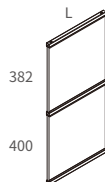

Model No.	Length (L)
2ACF8040FP-21	364mm
2ACF8060FP-21	564mm
2ACF8080FP-21	764mm

2ACF80FP-22
 2-Tier Acoustic Dual Face Frame
 *Height: 782mm

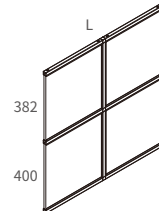

Model No.	Length (L)
2ACF8080FP-22	746 (382 + 364)mm
2ACF80120FP-22	1146 (582 + 564)mm

Eco Sound Acoustic Panels & Products

Wall-mounted acoustic cubes, with 2 keyholes

*Acoustic panel thickness 12mm

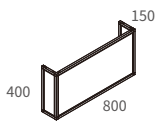
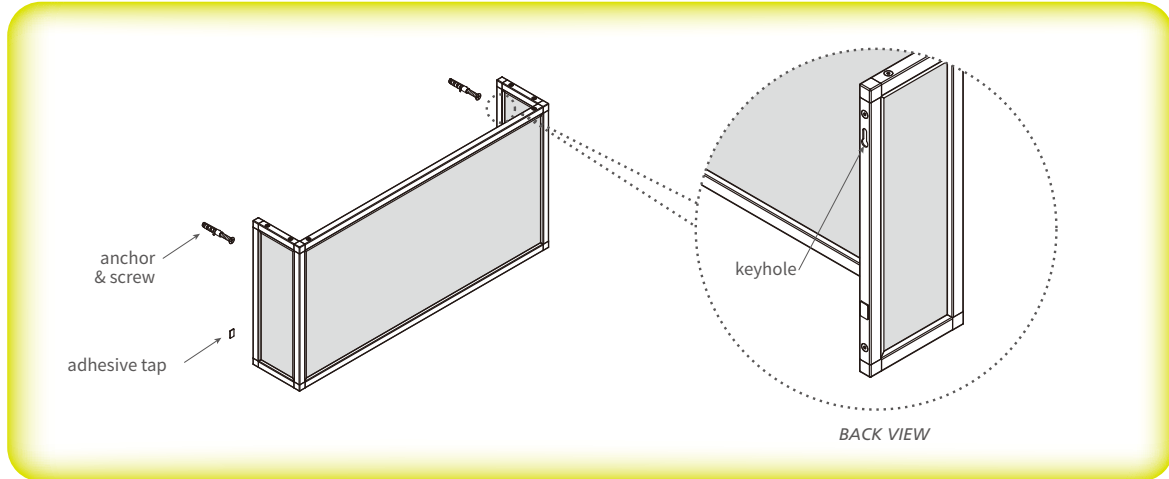

Components:
 1 x ACF1540SP-L
 1 x ACF1540SP-R
 1 x ACF4080FP-11

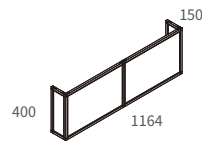

Components:
 1 x ACF1540SP-L
 1 x ACF1540SP-R
 1 x ACF40120FP-12

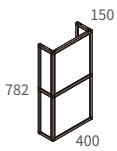

Components:
 1 x 2ACF1580SP-L
 1 x 2ACF1580SP-R
 1 x 2ACF8040FP-21

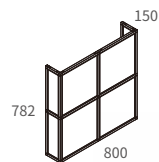

Components:
 1 x 2ACF1580SP-L
 1 x 2ACF1580SP-R
 1 x 2ACF8080FP-22

Eco Sound Acoustic Panels & Products

Ceiling-mounted Acoustic Panel 吊掛式吸音板

- * Acoustic panel thickness 12mm
- * With 2 x Ø10mm holes for M10 hanging bolt

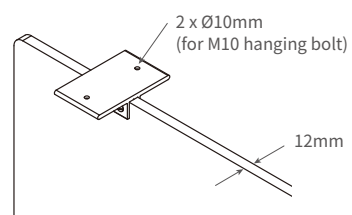

CM3080

- * (L) 800 x (W) 300mm

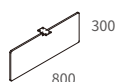

CM30120

- * (L) 1200 x (W) 300mm

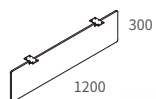

CM30160

- * (L) 1600 x (W) 300mm

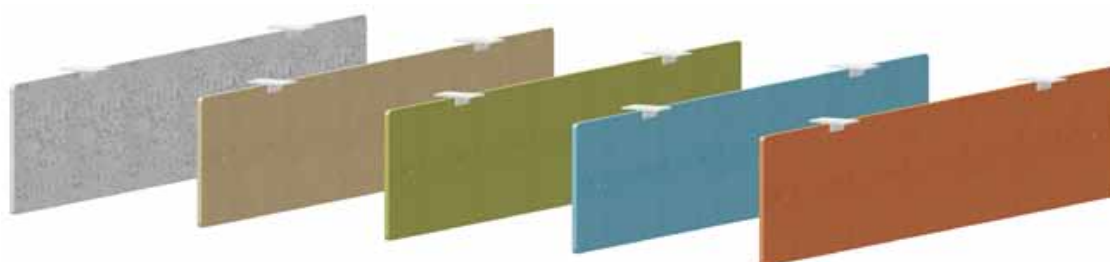
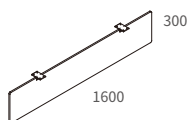

Алматы (7273)495-231
Ангарск (3955)60-70-56
Архангельск (8182)63-90-72
Астрахань (8512)99-46-04
Барнаул (3852)73-04-60
Белгород (4722)40-23-64
Благовещенск (4162)22-76-07
Брянск (4832)59-03-52
Владивосток (423)249-28-31
Владикавказ (8672)28-90-48
Владимир (4922)49-43-18
Волгоград (844)278-03-48
Вологда (8172)26-41-59
Воронеж (473)204-51-73
Екатеринбург (343)384-55-89

Иваново (4932)77-34-06
Ижевск (3412)26-03-58
Иркутск (395)279-98-46
Казань (843)206-01-48
Калининград (4012)72-03-81
Калуга (4842)92-23-67
Кемерово (3842)65-04-62
Киров (8332)68-02-04
Коломна (4966)23-41-49
Кострома (4942)77-07-48
Краснодар (861)203-40-90
Красноярск (391)204-63-61
Курск (4712)77-13-04
Курган (3522)50-90-47
Липецк (4742)52-20-81

Магнитогорск (3519)55-03-13
Москва (495)268-04-70
Мурманск (8152)59-64-93
Набережные Челны (8552)20-53-41
Нижний Новгород (831)429-08-12
Новокузнецк (3843)20-46-81
Ноябрьск (3496)41-32-12
Новосибирск (383)227-86-73
Омск (3812)21-46-40
Орел (4862)44-53-42
Оренбург (3532)37-68-04
Пенза (8412)22-31-16
Петрозаводск (8142)55-98-37
Псков (8112)59-10-37

Пермь (342)205-81-47
Ростов-на-Дону (863)308-18-15
Рязань (4912)46-61-64
Самара (846)206-03-16
Саранск (8342)22-96-24
Санкт-Петербург (812)309-46-40
Саратов (845)249-38-78
Севастополь (8692)22-31-93
Симферополь (3652)67-13-56
Смоленск (4812)29-41-54
Сочи (862)225-72-31
Ставрополь (8652)20-65-13
Сургут (3462)77-98-35
Сыктывкар (8212)25-95-17
Тамбов (4752)50-40-97

Тверь (4822)63-31-35
Тольятти (8482)63-91-07
Томск (3822)98-41-53
Тула (4872)33-79-87
Тюмень (3452)66-21-18
Ульяновск (8422)24-23-59
Улан-Удэ (3012)59-97-51
Уфа (347)229-48-12
Хабаровск (4212)92-98-04
Чебоксары (8352)28-53-07
Челябинск (351)202-03-61
Череповец (8202)49-02-64
Чита (3022)38-34-83
Якутск (4112)23-90-97
Ярославль (4852)69-52-93

Россия +7(495)268-04-70

Казахстан +7(7172)727-132

Киргизия +996(312)96-26-47

www.fourwinds.nt-rt.ru | | fse@nt-rt.ru