

Алматы (7273)495-231	Иваново (4932)77-34-06	Магнитогорск (3519)55-03-13	Пермь (342)205-81-47	Тверь (4822)63-31-35
Ангарск (3955)60-70-56	Ижевск (3412)26-03-58	Москва (495)268-04-70	Ростов-на-Дону (863)308-18-15	Тольятти (8482)63-91-07
Архангельск (8182)63-90-72	Иркутск (395)279-98-46	Мурманск (8152)59-64-93	Рязань (4912)46-61-64	Томск (3822)98-41-53
Астрахань (8512)99-46-04	Казань (843)206-01-48	Набережные Челны (8552)20-53-41	Самара (846)206-03-16	Тула (4872)33-79-87
Барнаул (3852)73-04-60	Калининград (4012)72-03-81	Нижний Новгород (831)429-08-12	Саранск (8342)22-96-24	Тюмень (3452)66-21-18
Белгород (4722)40-23-64	Калуга (4842)92-23-67	Новокузнецк (3843)20-46-81	Санкт-Петербург (812)309-46-40	Ульяновск (8422)24-23-59
Благовещенск (4162)22-76-07	Кемерово (3842)65-04-62	Ноябрьск (3496)41-32-12	Саратов (845)249-38-78	Улан-Удэ (3012)59-97-51
Брянск (4832)59-03-52	Киров (8332)68-02-04	Новосибирск (383)227-86-73	Севастополь (8692)22-31-93	Уфа (347)229-48-12
Владивосток (423)249-28-31	Коломна (4966)23-41-49	Омск (3812)21-46-40	Симферополь (3652)67-13-56	Хабаровск (4212)92-98-04
Владикавказ (8672)28-90-48	Кострома (4942)77-07-48	Орел (4862)44-53-42	Смоленск (4812)29-41-54	Чебоксары (8352)28-53-07
Владимир (4922)49-43-18	Краснодар (861)203-40-90	Оренбург (3532)37-68-04	Сочи (862)225-72-31	Челябинск (351)202-03-61
Волгоград (844)278-03-48	Красноярск (391)204-63-61	Пенза (8412)22-31-16	Ставрополь (8652)20-65-13	Череповец (8202)49-02-64
Вологда (8172)26-41-59	Курск (4712)77-13-04	Петрозаводск (8142)55-98-37	Сургут (3462)77-98-35	Чита (3022)38-34-83
Воронеж (473)204-51-73	Курган (3522)50-90-47	Псков (8112)59-10-37	Сыктывкар (8212)25-95-17	Якутск (4112)23-90-97
Екатеринбург (343)384-55-89	Липецк (4742)52-20-81		Тамбов (4752)50-40-97	Ярославль (4852)69-52-93

Россия +7(495)268-04-70

Казахстан +7(7172)727-132

Киргизия +996(312)96-26-47

www.fourwinds.nt-rt.ru | | fse@nt-rt.ru

Технические характеристики на каркасные системы для кухни CUBE18 компании **Four Winds**

Виды товаров: потолочные подвесные стеллажи-кубы с вешалками для чашек, подвесные шкафы с вешалкой и крючками, ножки каркаса шкафа, внутренние шкафы, крючки, каркасные тележки, кухонные острова, профили, панели, принадлежности, светодиодные светильники, драйверы постоянного тока, адаптеры и др.

CUBE18 Frame System in kitchen

- | *Adopt CUBE18 Frame System, spend less on kitchen cabinets*
- | *CUBE18 Frame System provides open and airy storage space in kitchen superseding all closed drawers and doors with invisible articles inside*
- | *CUBE18 Frame System lays out clear, easy and simple kitchen style*

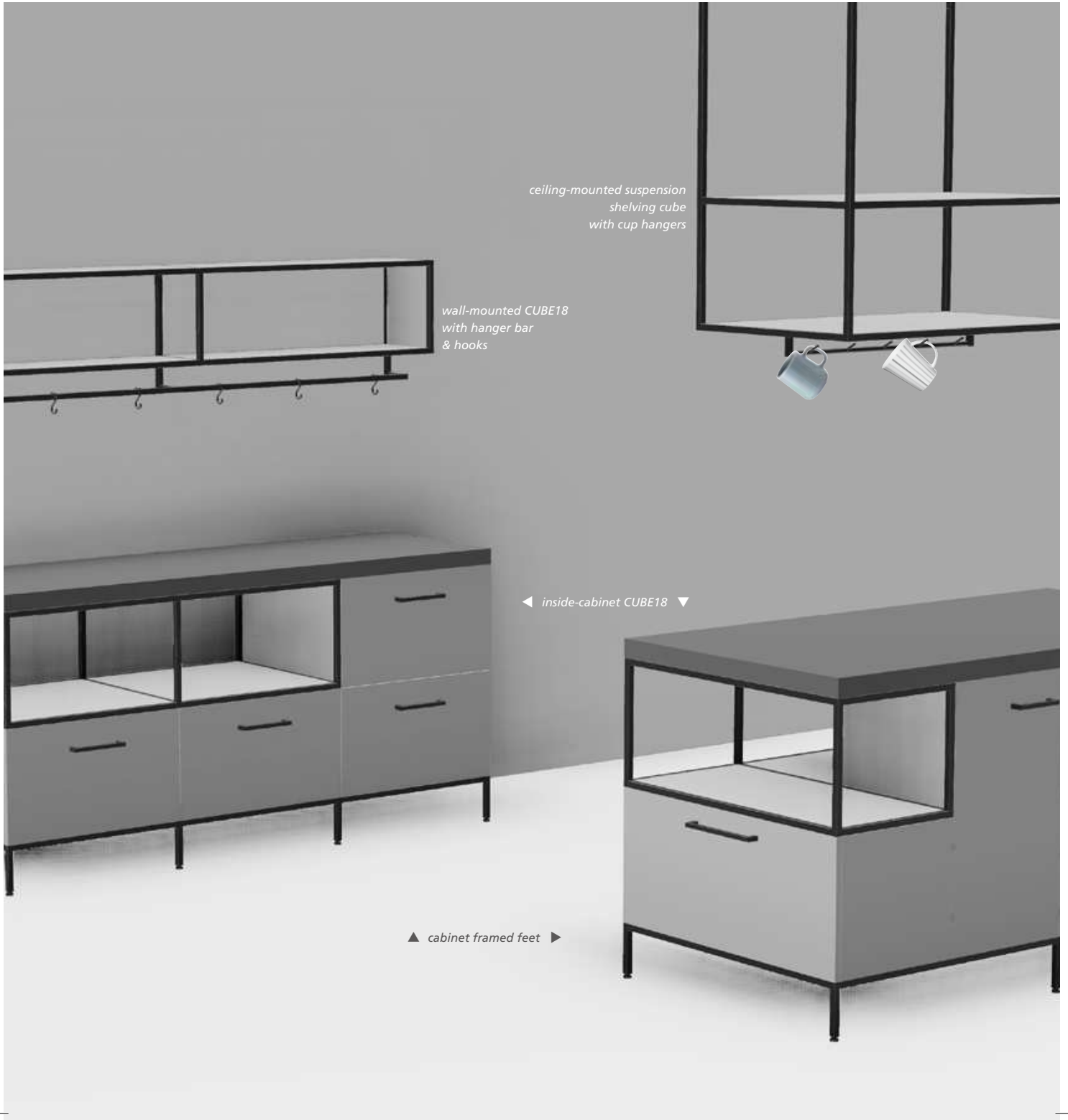

CUBE18 Frame System in kitchen

Wall-Mounted 1-Tier Shelf Cube Frame

* Key hole fixing

* Dimensions: (D) 250 x (H) 300mm

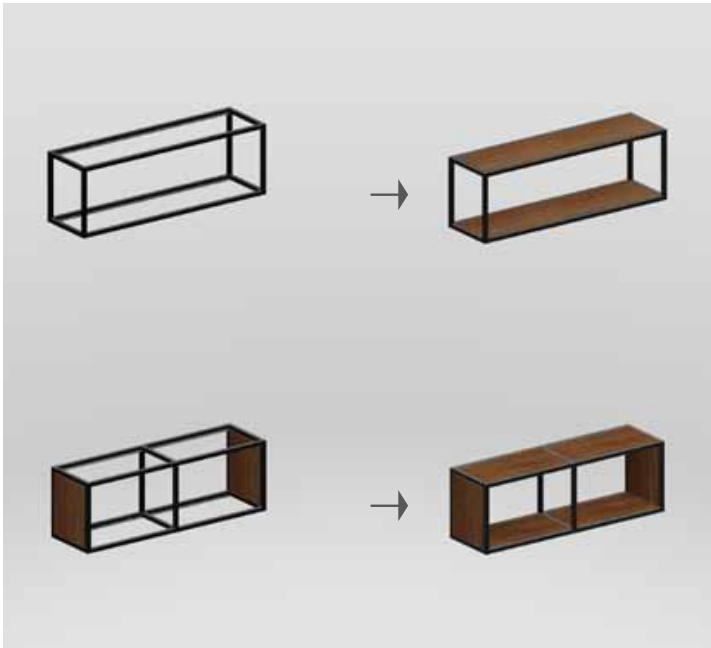

WM2530

* Without side panel (open-sided)

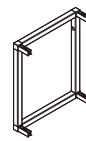
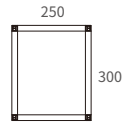

WM2530-L
(left side)

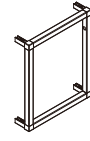

WM2530-R
(right side)

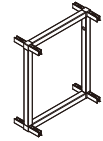

WM2530-HE
(extension link)

WM2530P

* With side panel

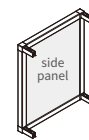

WM2530P-L
(left side)

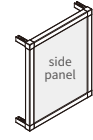

WM2530P-R
(right side)

Wall-Mounted L-Corner 1-Tier Shelf Frame

* Key hole fixing

* Dimensions: (D) 250 x (H) 300mm

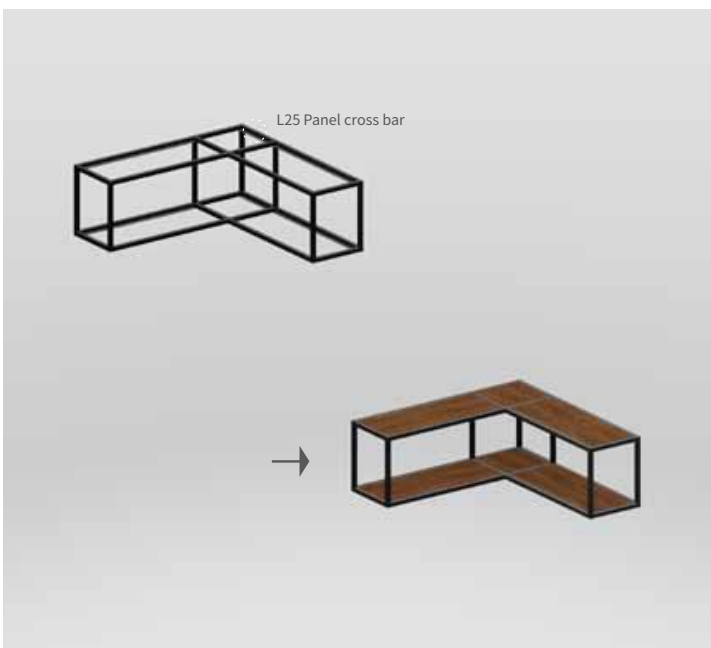

WM2530LC

L-corner shelf frame set

* 2 pcs / set

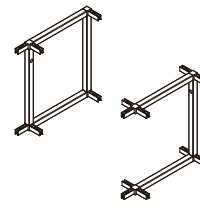
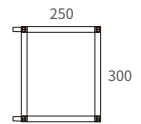

Panel cross bar for 1-tier L-corner

* Length: 214mm

* 4 pcs / set



L25-CB16
(16 or 18mm thick panel)



L25-CB8
(8mm thick panel)



L25-CB5
(5mm thick glass)

CUBE18 Frame System in kitchen

Wall-Mounted 2-Tier Shelf Cube Frame

* Key hole fixing

* Dimensions: (D) 250 x (H) 582 (300 + 282)mm

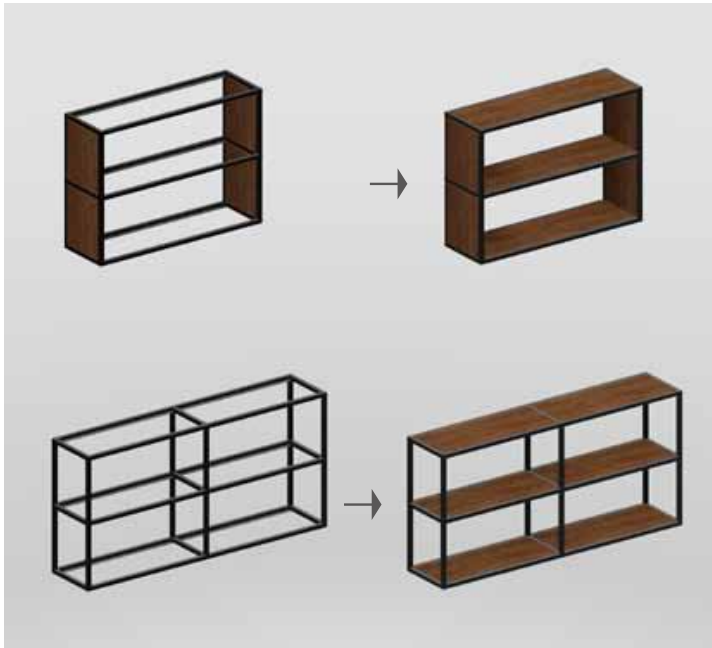

WM2530-2

* Without side panel (open-sided)

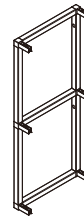
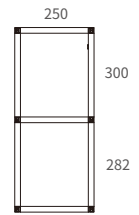

WM2530-2L
(left side)

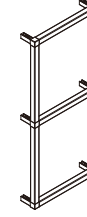

WM2530-2R
(right side)

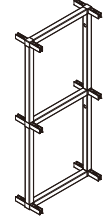

WM2530-2HE
(extension link)

WM2530P-2

* With side panel

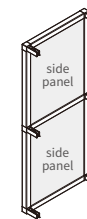

WM2530P-2L
(left side)

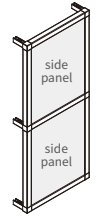

WM2530P-2R
(right side)

Wall-Mounted L-Corner 2-Tier Shelf Frame

* Key hole fixing

* Dimensions: (D) 250 x (H) 582 (300 + 282)mm

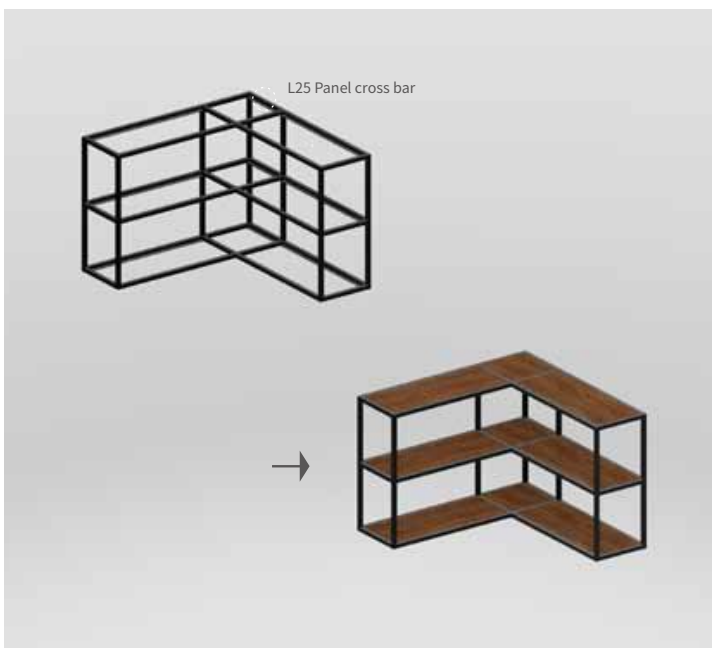

WM2530LC-2

L-corner 2-tier shelf frame set

* 2 pcs / set

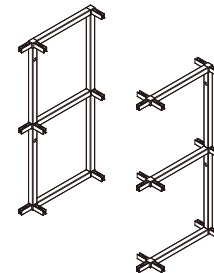
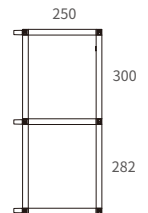

Panel cross bar for 2-tier L-corner

* Length: 214mm

* 6 pcs / set



L25-CB16
(16 or 18mm thick panel)



L25-CB8
(8mm thick panel)



L25-CB5
(5mm thick glass)

CUBE18 Frame System in kitchen

Wall-Mounted Towel & Hook Frame

- * Fixing dowels & screws
- * Dimensions: (D) 110 x (H) 18mm

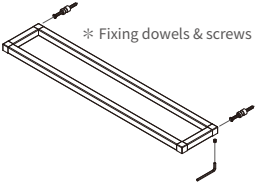
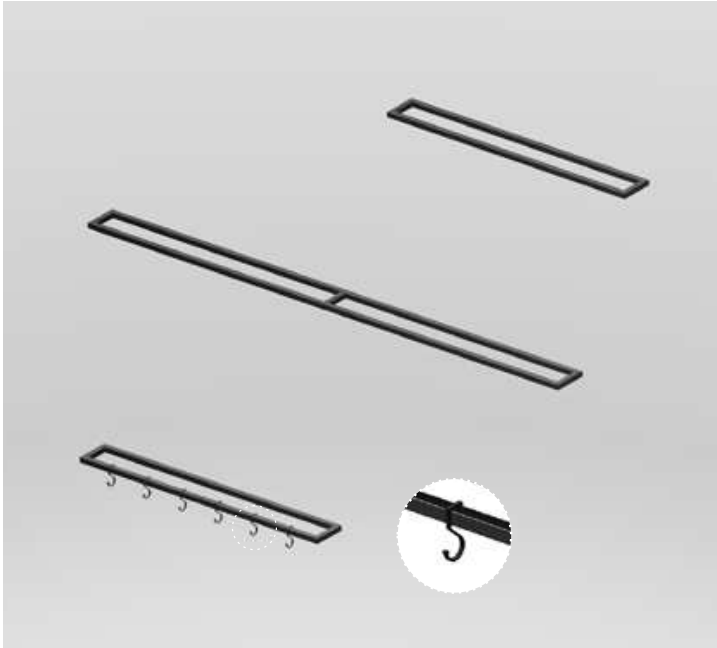

WM11DF
* For towel or kitchenware



WM11DF-SD
(left or right side frame)

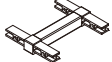

WM11DF-HE
(extension link)

SQ18AH Aluminium hook
* Dimensions: (W) 31.4 x (H) 65 x (T) 5.5mm

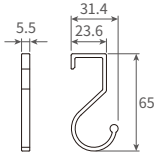

Hanger for towel or kitchenware



Hanger for mug & cup



CUBE18 Frame System in kitchen

Wall-Mounted Shelf Frame

* Fixing dowels & screws

* Dimensions: (D) 150 x (H) 18mm

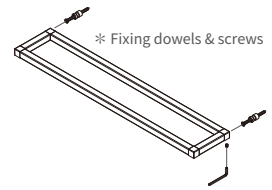
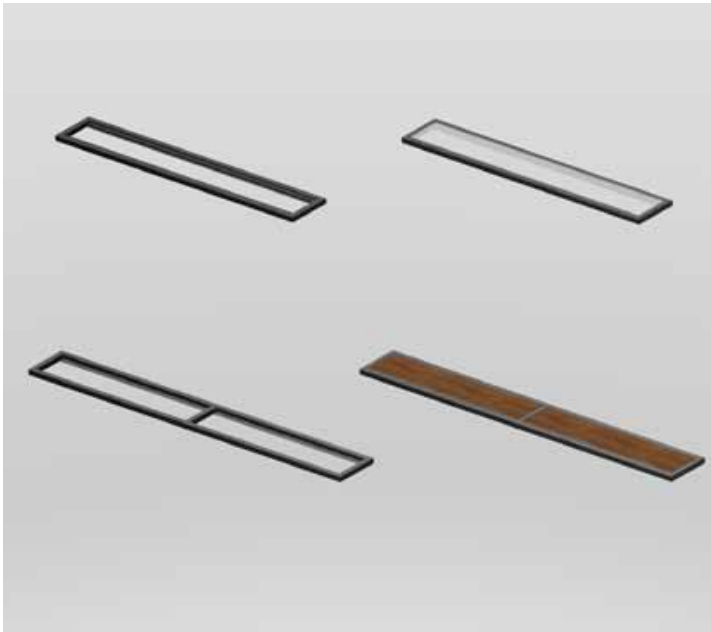

WM15DF

* For glass or wooden shelf panel

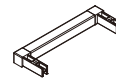
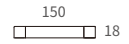

WM15DF-SD
(left or right side frame)

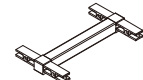

WM15DF-HE
(extension link)

Shelf with flush glass panel (5mm thickness)



Wall & Top Mounted Shelf Cube Frame

* Key hole fixing

* Dimensions: (D) 150 x (H) 200mm

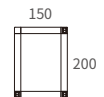
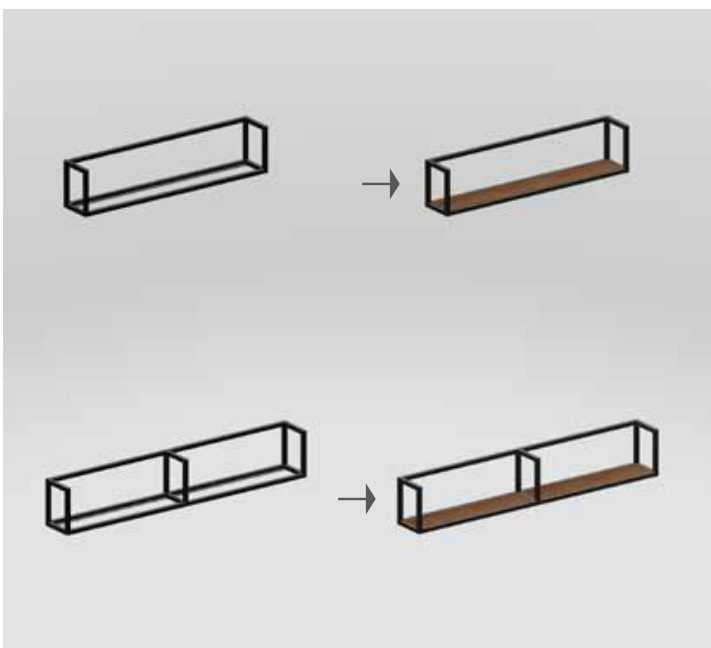

WM1520C

* Without side panel (open-sided)



WM1520C-L
(left side)

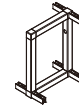

WM1520C-R
(right side)

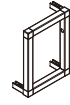

WM1520C-HE
(extension link)

WM1520CP

* With side panel



WM1520CP-L
(left side)

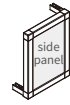

WM1520CP-R
(right side)

CUBE18 Frame System in kitchen

Wall & Top Mounted Shelf Cube Frame, with hanging bar

* Key hole fixing

* Dimensions: (D) 150 x (H) 242 (150 + 92)mm

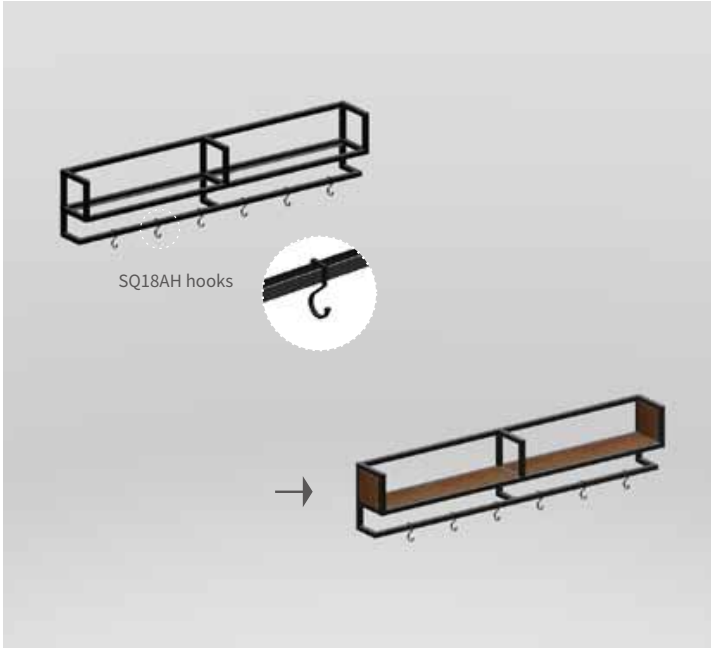

WM1515CHB

* Without side panel (open-sided)

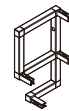
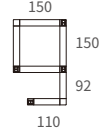

WM1515CHB-L
(left side)

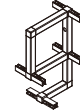

WM1515CHB-R
(right side)

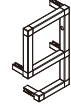

WM1515CHB-HE
(extension link)

WM1515CHBP

* With side panel

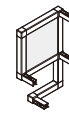

WM1515CHBP-L
(left side)

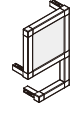

WM1515CHBP-R
(right side)

Wall & Top Mounted Shelf Cube Frame, with hanging bar

* Key hole fixing

* Dimensions: (D) 250 x (H) 392 (300 + 92)mm



WM2530HB

* Without side panel (open-sided)

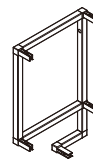
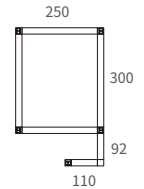

WM2530HB-L
(left side)

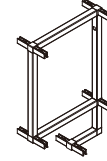

WM2530HB-R
(right side)

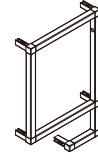

WM2530HB-HE
(extension link)

WM2530HBP

* With side panel

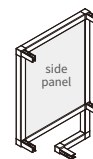

WM2530HBP-L
(left side)

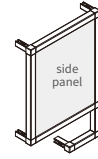

WM2530HBP-R
(right side)

CUBE18 Frame System in kitchen

Wall-Mounted Inset panel Shelf Frame

* Key hole fixing

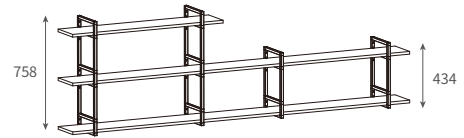

WM-43IP

* Height: 434mm

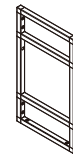
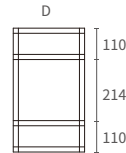

WM-2543IP
(D) 250mm

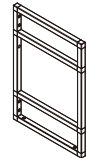

WM-3043IP
(D) 300mm

WM-76IP

* Height: 758mm

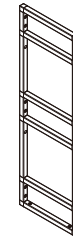
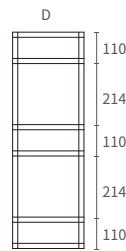

WM-2576IP
(D) 250mm

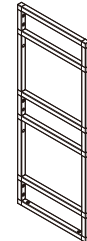

WM-3076IP
(D) 300mm

Trolley Frame, with PCX50 wheel castor

* L= 600 & 900mm

RF2-4590 Trolley Frame

* Dimensions: (D) 450 x (H) 925mm



RF2-6090 Trolley Frame

* Dimensions: (D) 600 x (H) 925mm



CUBE18 Frame System in kitchen

Freestanding CUBE18 Storage Frame

* Stands on counter top (under cabinet or kitchen island) for food, beverage, plant storage or display,
with adhesive bumpers (Ø17.8 x 4mm)

1-Tier Storage Frame

* Dimensions: (D) 250 x (H) 114mm

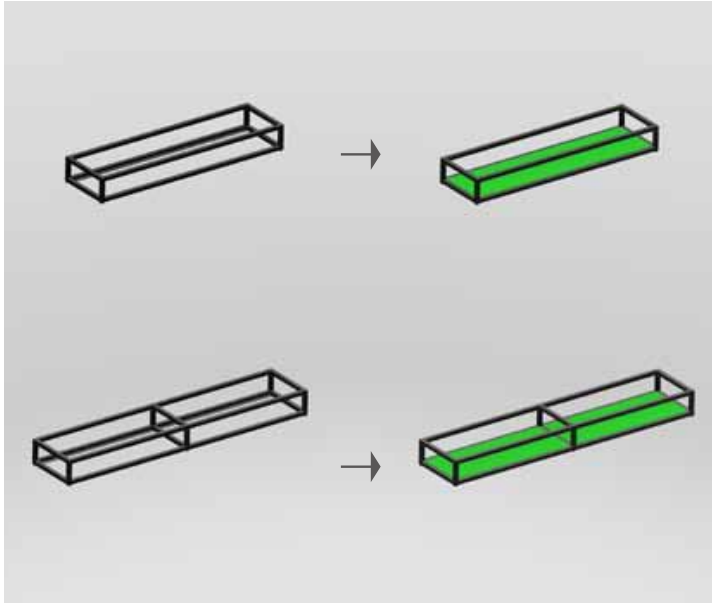

DSF2511-SD Side frame

* For left or right side frame

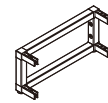
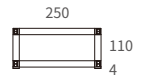

DSF2511-HE Extension frame

* Linking left & right side frames

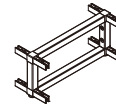

2-Tier Shelf Frame

* Dimensions: (D) 250 x (H) 438mm

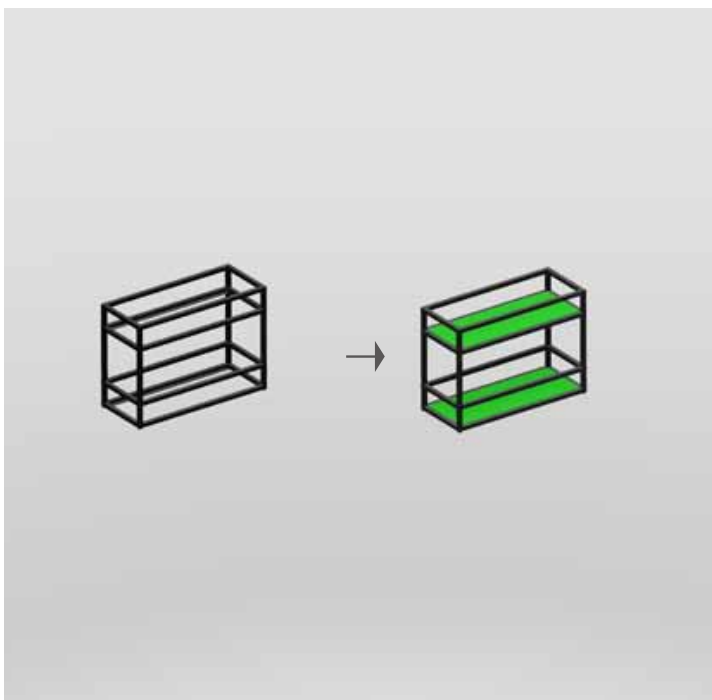

DSF2544-SD Side frame

* For left or right side frame

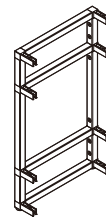
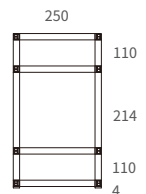

DSF2544-HE Extension frame

* Linking left & right side frames

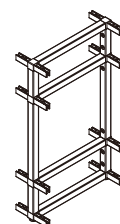

CUBE18 Frame System in kitchen

Inside-Cabinet CUBE18 & Cabinet Framed Feet

Kitchen Cabinet



Dimensions: (L) 1782 x (D) 600 x (H) 900mm

Side Cabinet



Dimensions: (L) 1582 x (D) 400 x (H) 1114mm

Kitchen Island



Dimensions: (L) 1600 x (D) 800 x (H) 900mm

CUBE18 Frame System in kitchen

1-Tier Shelf Cube Frame

* Height: 340mm

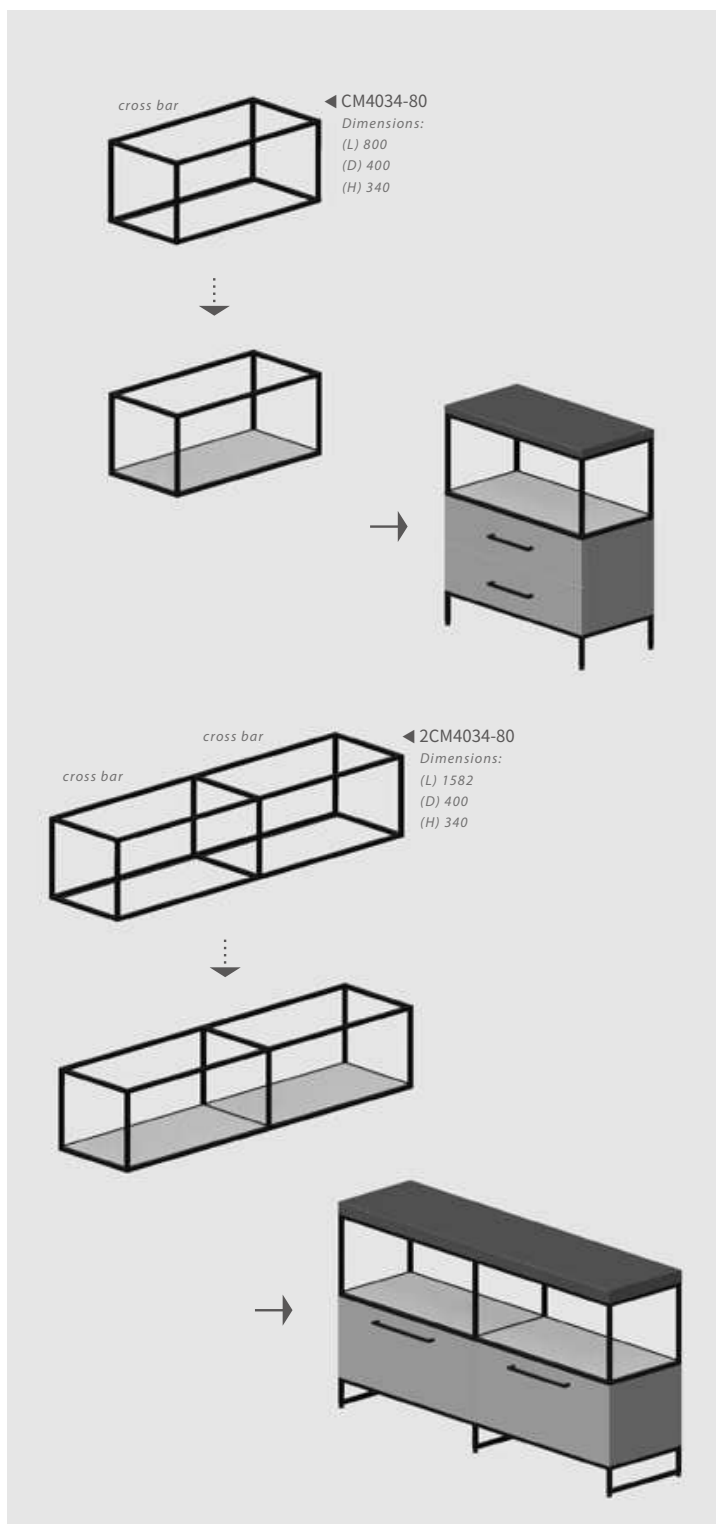

Side Frame

* Left or right side frame

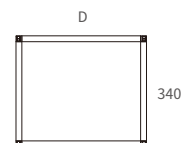

CM4034-SD
(D) 400mm

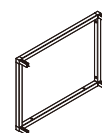

CM4534-SD
(D) 450mm

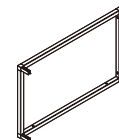

CM5634-SD
(D) 560mm

Extension Frame

* Linking left & right side frames

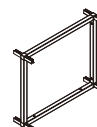

CM4034-HE
(D) 400mm

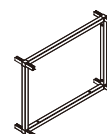

CM4534-HE
(D) 450mm

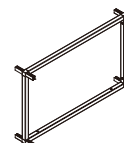

CM5634-HE
(D) 560mm

CUBE18 Frame System in kitchen

2-Tier Shelf Cube Frame

* Height: 662 (340 + 322)mm

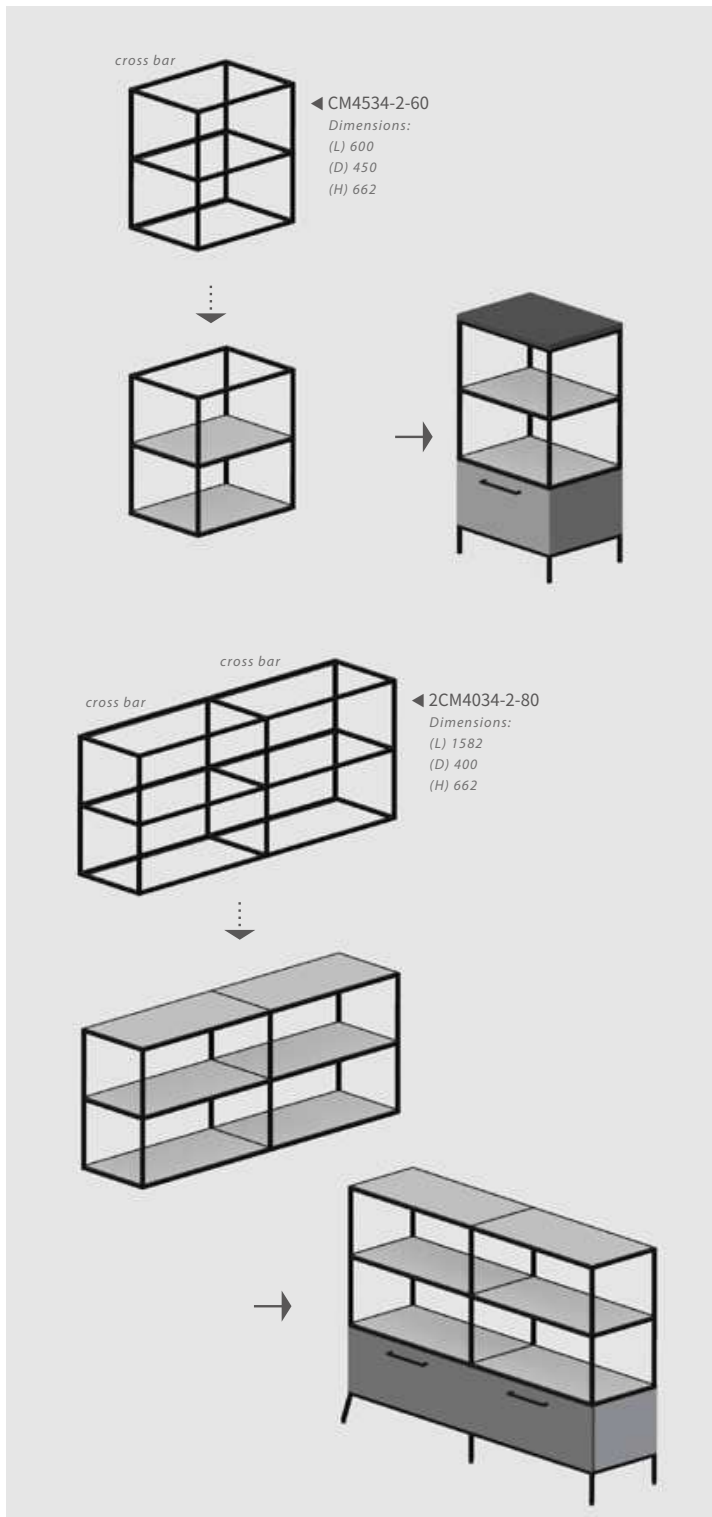

Side Frame

* Left or right side frame

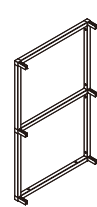
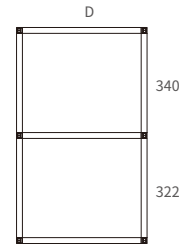

CM4034-2SD
(D) 400mm

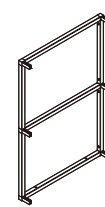

CM4534-2SD
(D) 450mm

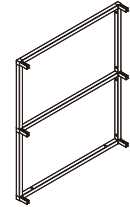

CM5634-2SD
(D) 560mm

Extension Frame

* Linking left & right side frames

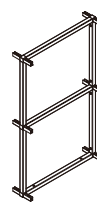

CM4034-2HE
(D) 400mm

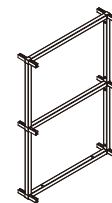

CM4534-2HE
(D) 450mm

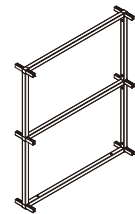

CM5634-2HE
(D) 560mm

CUBE18 Frame System in kitchen

DSF Cabinet Framed Feet

* Mounted under cabinet

cross bar

DSF45SD-162

DSF45SD-162

DSF4590-162

Dimensions:
(L) 900
(D) 450
(H) 162

18 L 18

D

*L=432, 582, 882 & 1182mm
*CB16-SH-C (2400mm length), cuttable length fulfilling the demand

cross bar

cross bar

DSF40SD-262

DSF40HE-262

DSF40SD-262

2DSF4080-262

Dimensions:
(L) 1582
(D) 400
(H) 262

18 L 18 L 18

D

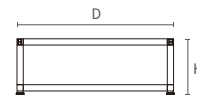

DSF-SD Side Framed Feet

* Left or right side frame

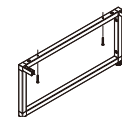

Model No.	D (Depth)	H (Height)
DSF40SD-162	400mm	
DSF45SD-162	450mm	
DSF50SD-162	500mm	162mm
DSF56SD-162	560mm	
DSF60SD-162	600mm	
DSF40SD-212	400mm	
DSF45SD-212	450mm	
DSF50SD-212	500mm	212mm
DSF56SD-212	560mm	
DSF60SD-212	600mm	
DSF40SD-262	400mm	
DSF45SD-262	450mm	
DSF50SD-262	500mm	262mm
DSF56SD-262	560mm	
DSF60SD-262	600mm	

DSF-HE Extension Framed Feet

* Linking left & right side frames

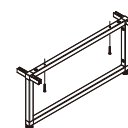

Model No.	D (Depth)	H (Height)
DSF40HE-162	400mm	
DSF45HE-162	450mm	
DSF50HE-162	500mm	162mm
DSF56HE-162	560mm	
DSF60HE-162	600mm	
DSF40HE-212	400mm	
DSF45HE-212	450mm	
DSF50HE-212	500mm	212mm
DSF56HE-212	560mm	
DSF60HE-212	600mm	
DSF40HE-262	400mm	
DSF45HE-262	450mm	
DSF50HE-262	500mm	262mm
DSF56HE-262	560mm	
DSF60HE-262	600mm	

CUBE18 Frame System in kitchen

FSR Cabinet Framed Feet

* Mounted under cabinet

FSR4590-198
 Dimensions:
 (L) 900
 (D) 450
 (H) 198

FSR45SD-198

FSR45SD-198

*L=432, 582, 882 & 1182mm
 *CB16-SH-C (2400mm length), cuttable length fulfilling the demand

2FSR4580-148
 Dimensions:
 (L) 1582
 (D) 450
 (H) 148

FSR45SD-148

FSR45HE-148

FSR45SD-148

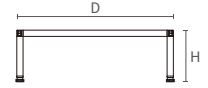

FSR-SD Side Framed Feet

* Left or right side frame

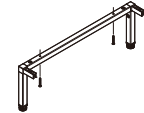

Model No.	D (Depth)	H (Height)
FSR40SD-148	400mm	
FSR45SD-148	450mm	
FSR50SD-148	500mm	148mm
FSR56SD-148	560mm	
FSR60SD-148	600mm	
FSR40SD-198	400mm	
FSR45SD-198	450mm	
FSR50SD-198	500mm	198mm
FSR56SD-198	560mm	
FSR60SD-198	600mm	
FSR40SD-248	400mm	
FSR45SD-248	450mm	
FSR50SD-248	500mm	248mm
FSR56SD-248	560mm	
FSR60SD-248	600mm	

FSR-HE Extension Framed Feet

* Linking left & right side frames

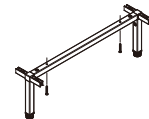

Model No.	D (Depth)	H (Height)
FSR40HE-148	400mm	
FSR45HE-148	450mm	
FSR50HE-148	500mm	148mm
FSR56HE-148	560mm	
FSR60HE-148	600mm	
FSR40HE-198	400mm	
FSR45HE-198	450mm	
FSR50HE-198	500mm	198mm
FSR56HE-198	560mm	
FSR60HE-198	600mm	
FSR40HE-248	400mm	
FSR45HE-248	450mm	
FSR50HE-248	500mm	248mm
FSR56HE-248	560mm	
FSR60HE-248	600mm	

CUBE18 Frame System in kitchen

SSL Mono Slant Cabinet Framed Feet

* Mounted under cabinet, securely loading the cabinet against the wall

SSL4590-148
Dimensions:
(L) 900
(D) 450
(H) 148

SSL45L-148
SSL45R-148

*L=432, 582, 882 & 1182mm
*CB16-SH-C (2400mm length), cuttable length fulfilling the demand

2SSL4060-148
Dimensions:
(L) 1582
(D) 450
(H) 148

SSL40L-148
FSR40HE-148
SSL40R-148

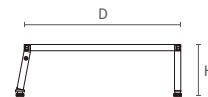

SSL-L Side Framed Feet

*Left side frame

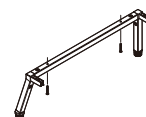

Model No.	D (Depth)	H (Height)
SSL40L-148	400mm	
SSL45L-148	450mm	
SSL50L-148	500mm	148mm
SSL56L-148	560mm	
SSL60L-148	600mm	
SSL40L-198	400mm	
SSL45L-198	450mm	
SSL50L-198	500mm	198mm
SSL56L-198	560mm	
SSL60L-198	600mm	
SSL40L-248	400mm	
SSL45L-248	450mm	
SSL50L-248	500mm	248mm
SSL56L-248	560mm	
SSL60L-248	600mm	

SSL-R Side Framed Feet

*Right side frame

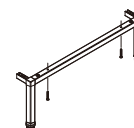

Model No.	D (Depth)	H (Height)
SSL40R-148	400mm	
SSL45R-148	450mm	
SSL50R-148	500mm	148mm
SSL56R-148	560mm	
SSL60R-148	600mm	
SSL40R-198	400mm	
SSL45R-198	450mm	
SSL50R-198	500mm	198mm
SSL56R-198	560mm	
SSL60R-198	600mm	
SSL40R-248	400mm	
SSL45R-248	450mm	
SSL50R-248	500mm	248mm
SSL56R-248	560mm	
SSL60R-248	600mm	

CUBE18 Frame System in kitchen

TSL Dual Slant Cabinet Framed Feet

* Mounted under cabinet, seating the freestanding cabinet steadily

◀ TSL4590-198
 Dimensions:
 (L) 900
 (D) 450
 (H) 198

TSL45SD-198

TSL45SD-198

*L=432, 582, 882 & 1182mm
 *CB16-SH-C (2400mm length), cuttable length fulfilling the demand

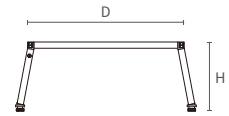

TSL-SD Side Framed Feet

* Left or right side frame

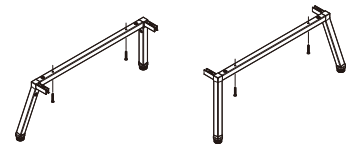

Model No.	D (Depth)	H (Height)
TSL40SD-148	400mm	148mm
TSL45SD-148	450mm	
TSL50SD-148	500mm	
TSL56SD-148	560mm	
TSL60SD-148	600mm	198mm
TSL40SD-198	400mm	
TSL45SD-198	450mm	
TSL50SD-198	500mm	
TSL56SD-198	560mm	248mm
TSL60SD-198	600mm	
TSL40SD-248	400mm	
TSL45SD-248	450mm	
TSL50SD-248	500mm	248mm
TSL56SD-248	560mm	
TSL6SD-248	600mm	

CUBE18 Frame System in kitchen

Ceiling-Mounted Suspension Shelving Cube

* Fixed on ceiling surface securely with steel bolt (M10) and anchor

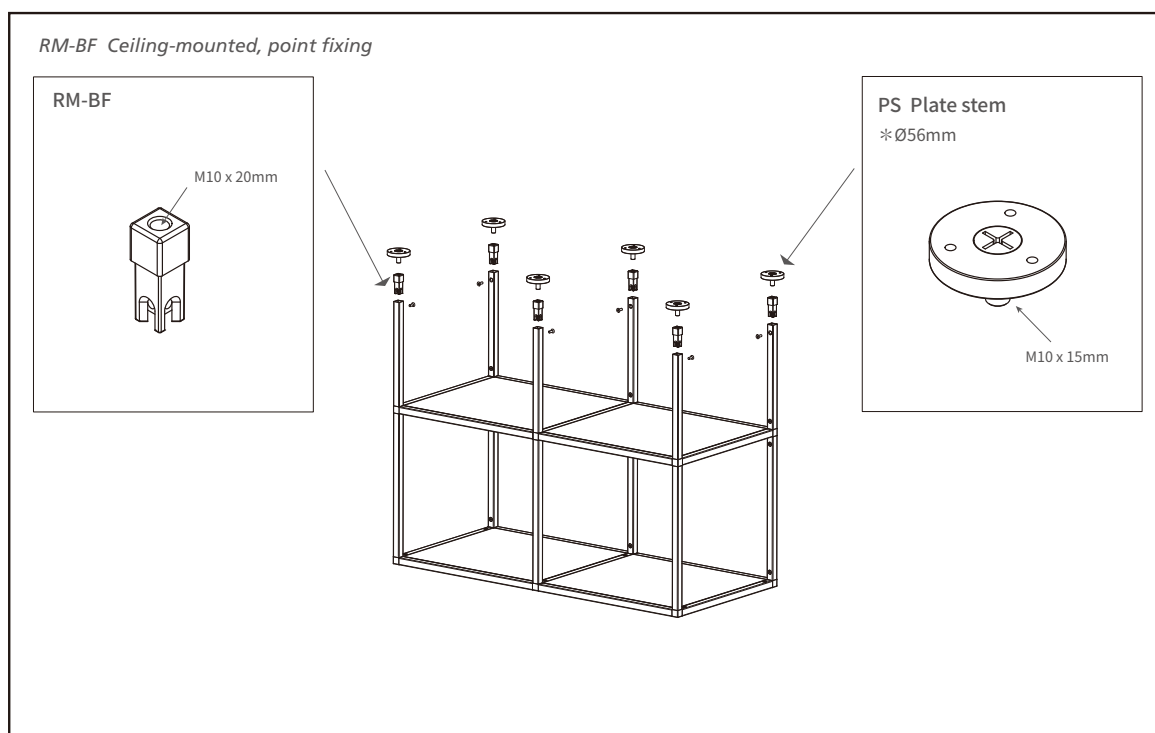
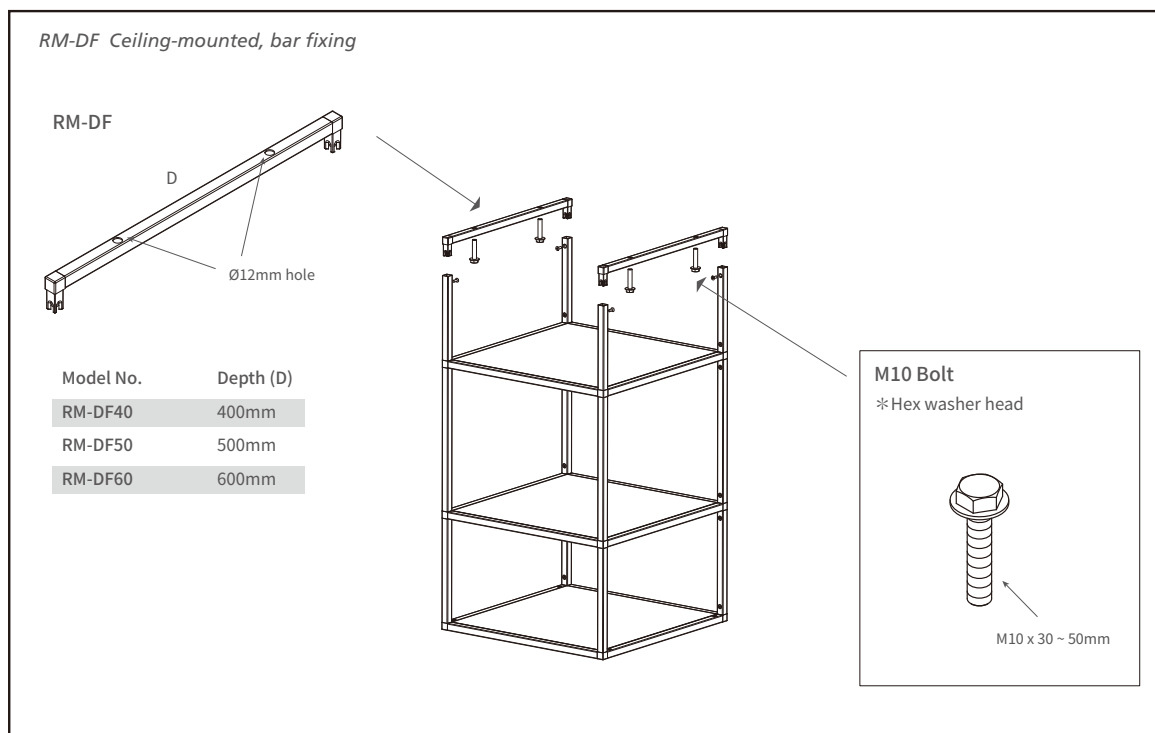

CUBE18 Frame System in kitchen

Ceiling-Mounted 2-Tier Shelf Frame

* Height: 482 ~ 832mm

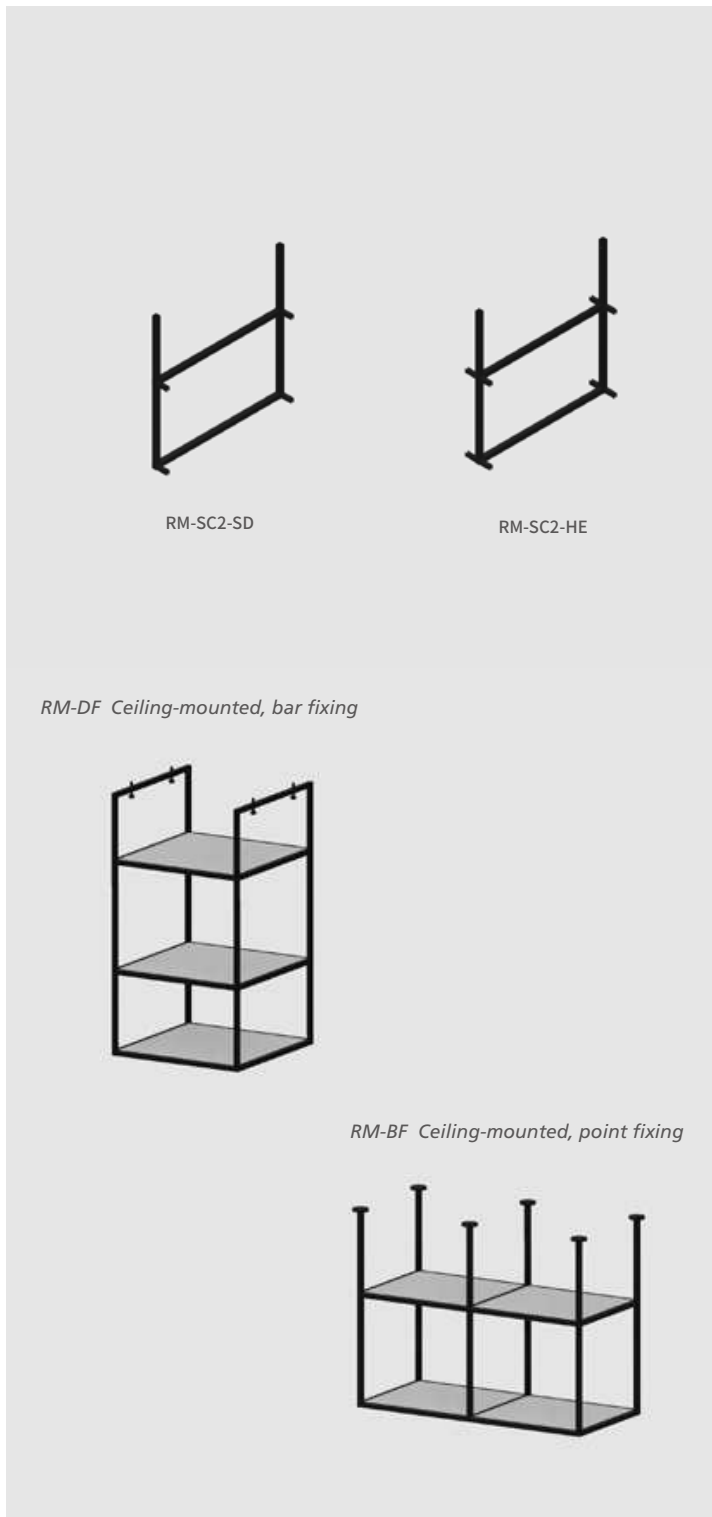

RM-SC2-SD Side frame

- * For left or right side frame
- * T= 214, 264, 304 & 364mm
- * B= 250, 300, 340 & 400mm
- * D= 400, 500 & 600mm

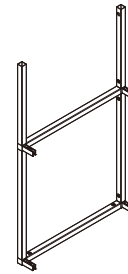
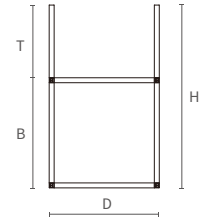

RM-SC2-HE Extension frame

- * Linking left & right side frames
- * T= 214, 264, 304 & 364mm
- * B= 250, 300, 340 & 400mm
- * D= 400, 500 & 600mm

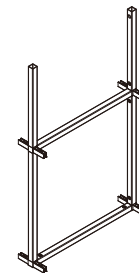

CUBE18 Frame System in kitchen

Ceiling-Mounted 2-Tier Shelf Frame, with side panel

* Height: 482 ~ 832mm

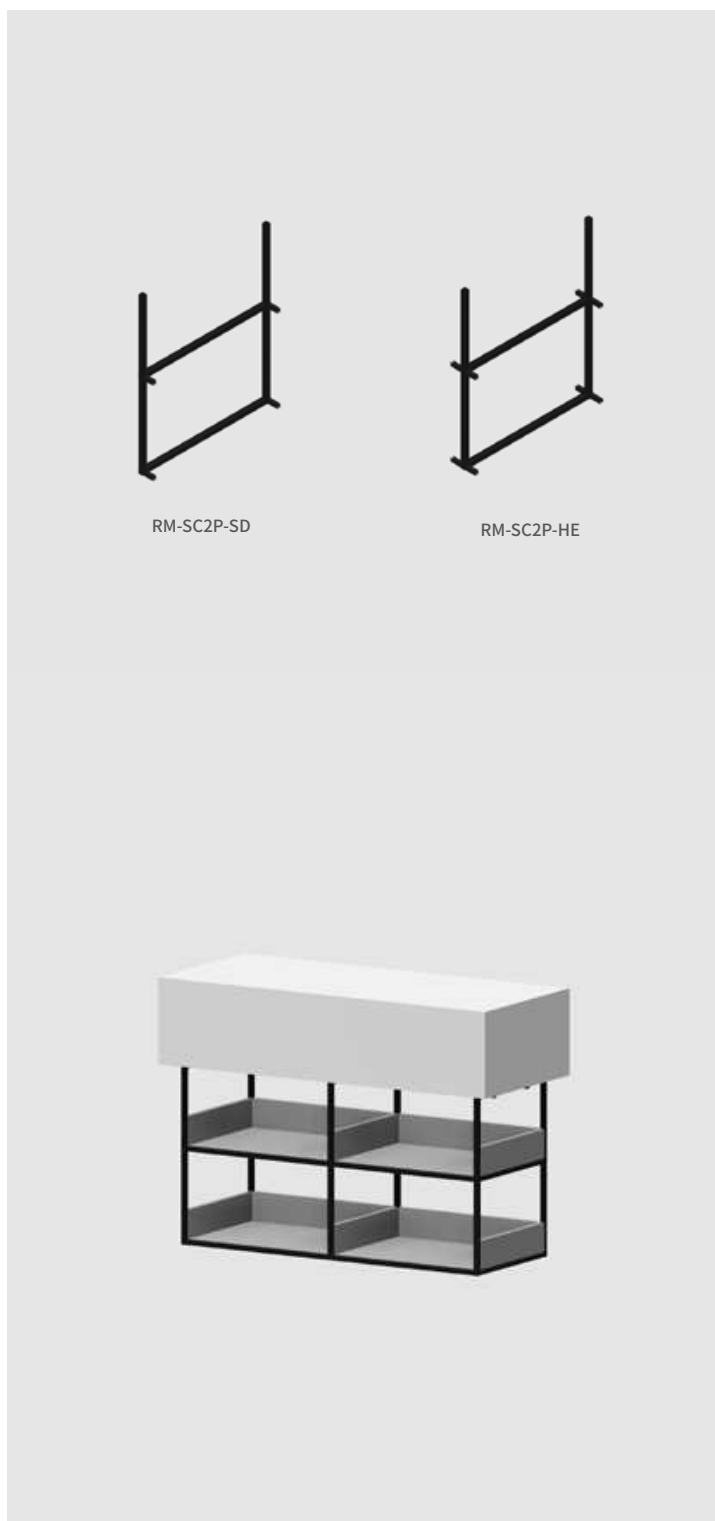

RM-SC2P-SD Side frame, with side panel

- * For left or right side frame
- * T= 214, 264, 304 & 364mm
- * B= 250, 300, 340 & 400mm
- * D= 400, 500 & 600mm

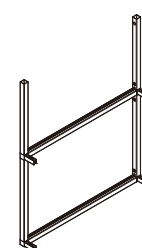
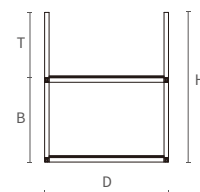

RM-SC2P-SD

RM-SC2P-HE

Side Panel

* 18mm thickness

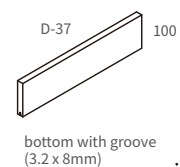

RM-SC2P-HE

Extension frame, with side panel

- * Linking left & right side frames
- * T= 214, 264, 304 & 364mm
- * B= 250, 300, 340 & 400mm
- * D= 400, 500 & 600mm

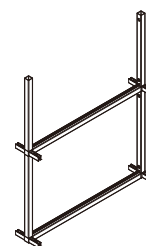

CUBE18 Frame System in kitchen

Ceiling-Mounted 3-Tier Shelf Frame

* Height: 814 ~ 1214mm



RM-SC3-SD Side frame

- * For left or right side frame
- * T= 214, 264, 304 & 364mm
- * B= 250, 300, 340 & 400mm
- * D= 400, 500 & 600mm

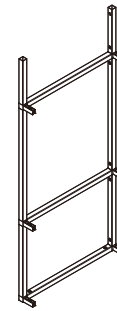
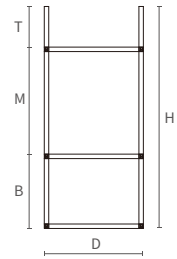

RM-SC3-HE Extension frame

- * Linking left & right side frames
- * T= 214, 264, 304 & 364mm
- * B= 250, 300, 340 & 400mm
- * D= 400, 500 & 600mm

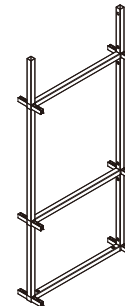

CUBE18 Frame System in kitchen

Ceiling-Mounted 3-Tier Shelf Frame, with side panel

* Height: 814 ~ 1214mm

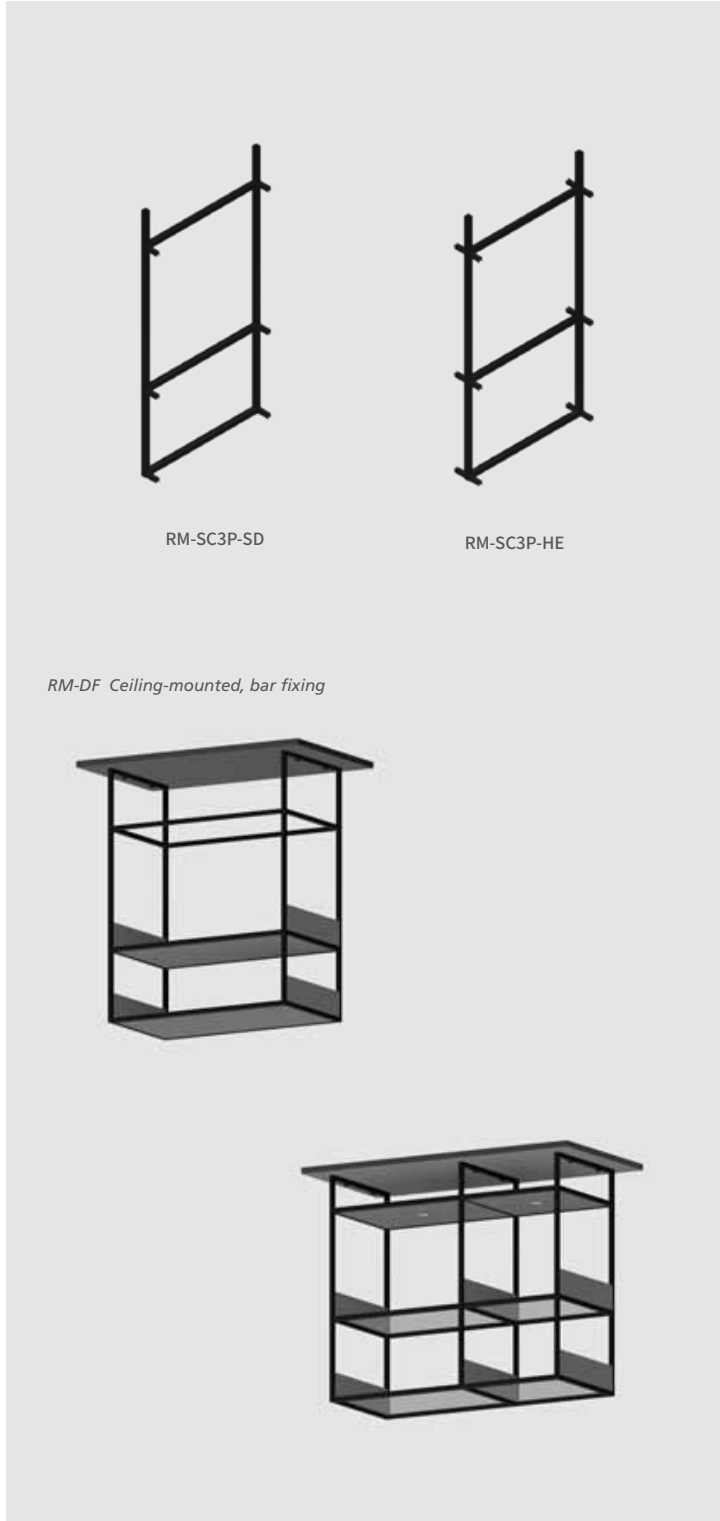

RM-SC3P-SD Side frame, with side panel

- * For left or right side frame
- * T= 214, 264, 304 & 364mm
- * B= 250, 300, 340 & 400mm
- * D= 400, 500 & 600mm

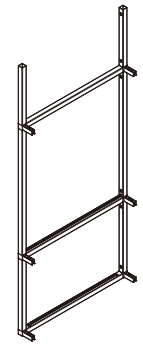
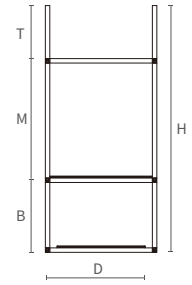

Side Panel

* 18mm thickness

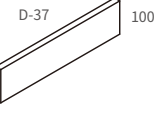

RM-SC3P-HE Extension frame, with side panel

- * Linking left & right side frames
- * T= 214, 264, 304 & 364mm
- * B= 250, 300, 340 & 400mm
- * D= 400, 500 & 600mm

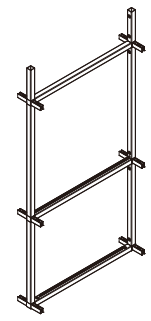

CUBE18 Frame System in kitchen

Ceiling-Mounted Inset Panel Shelf Frame

* Depth (D): 400, 500 & 600mm

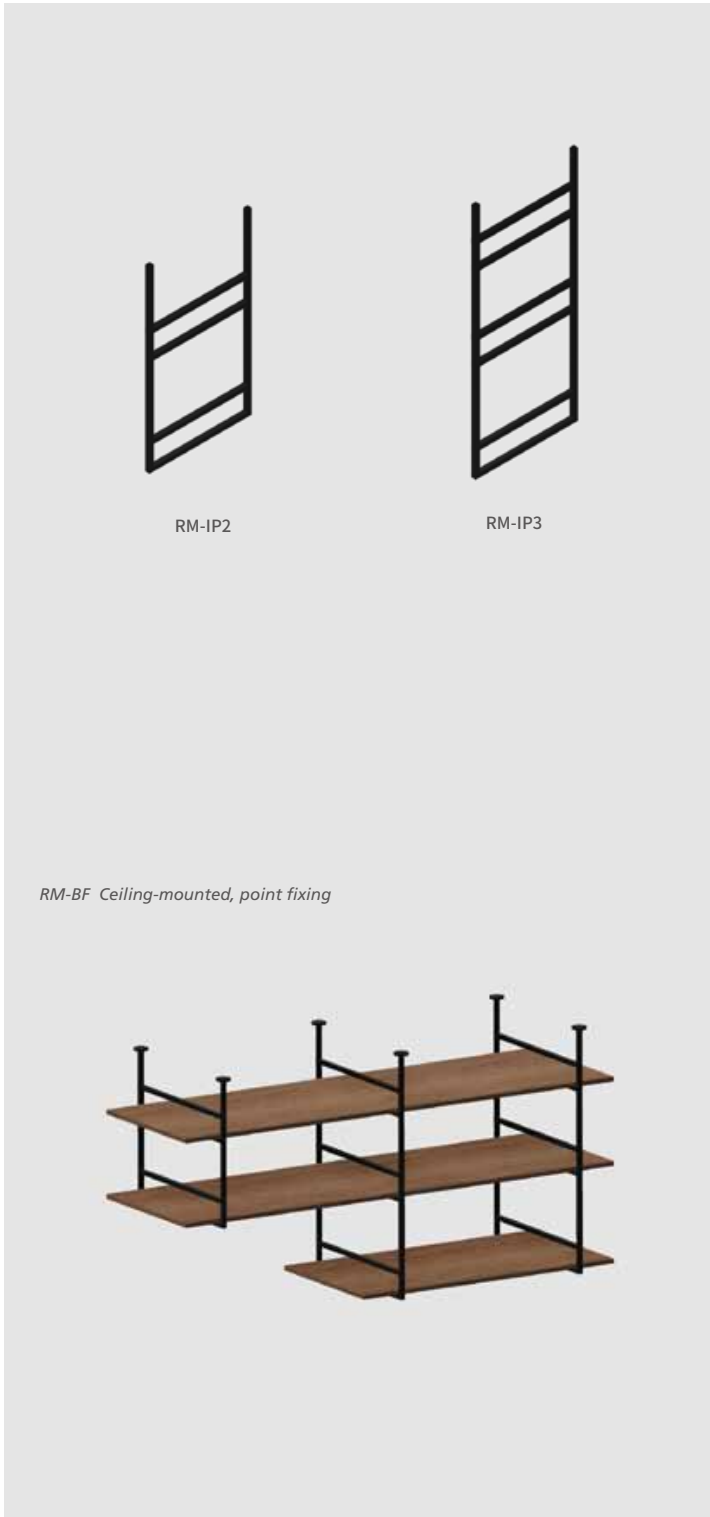

RM-IP2

2-Tier Inset panel shelf frame

* T= 114, 164 & 214mm

* H= 214, 264 & 314mm

* D= 400, 500 & 600mm

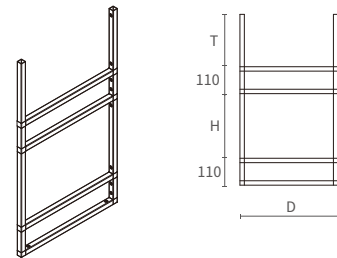

RM-IP3

3-Tier Inset panel shelf frame

* T= 114, 164 & 214mm

* H= 214, 264 & 314mm

* D= 400, 500 & 600mm

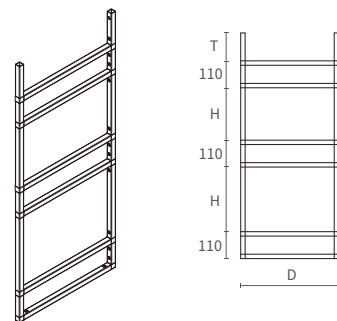

CUBE18 Frame System in kitchen

For better utility of ceiling-mounted shelving cube, LED down light is suggested to be added under the top panel and mug & cup hanger

LED down light under top panel



PLD200 5W LED Down Light

* Drillhole: $\varnothing 68 \times 15\text{mm}$, recessed mounting

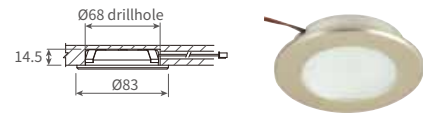

DC700 DC driver

* 12 / 24 Vdc 0.7A constant current



WM12W Wall-mounted AC to DC adapter

* 12 Vdc 1A, 100 ~ 240 Vac



DI-UHK65-5 Mug & cup hanger under bottom panel



DI-UHK65-5DB Mug & Cup Hanger

* Aluminium, dark bronzed

* Dimensions: (L) 672 x (H) 64mm, (C.C.) 650mm

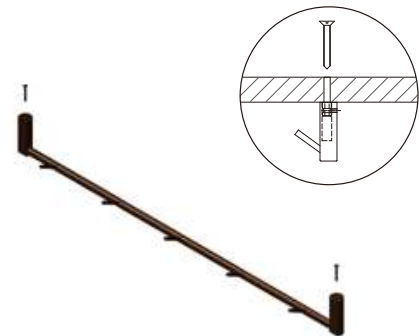
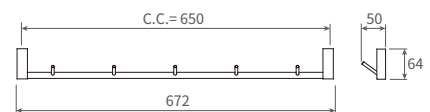

CUBE18 Frame System in kitchen

Kitchen Island CUBE18 L-Screen

*Ideal for kitchen island

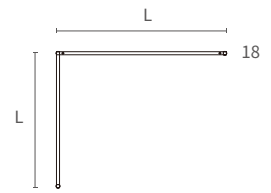
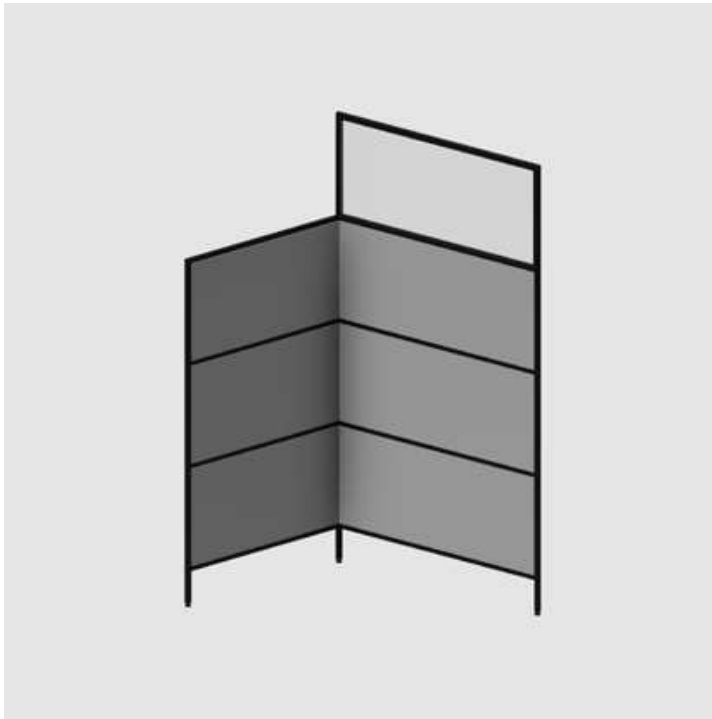

L-Screen

* Screen frame fits the following:

- A. 5mm thick glass panel
 - B. 8mm thick solid wooden panel
(compact & laminated chipboard)
 - C. 18mm thick laminated chipboard (with groove)
- *L= 800, 900, 1000 & 1200mm

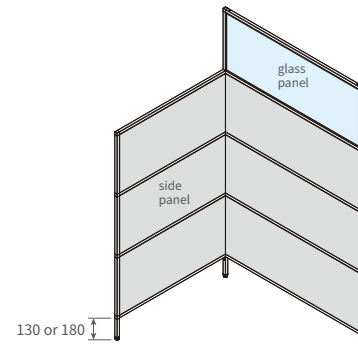

CUBE18 Frame System in kitchen

L Cube Cross Bar

L-CB16 Shelf panel cross bar

*16.5mm inner depth, for 5 ~ 18mm inset shelf panel

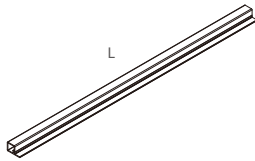

Model No.	L (Length)
L45-CB16	414mm
L60-CB16	564mm
L80-CB16	764mm
L90-CB16	864mm
L120-CB16	1164mm

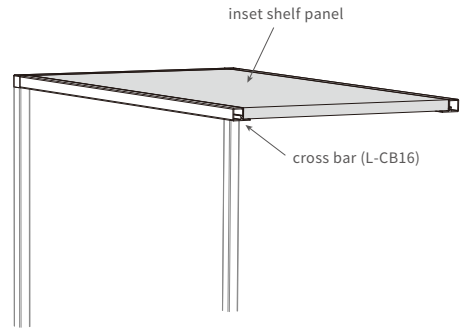

L-CB8 Shelf panel cross bar

*8.5mm inner depth, for 8 ~ 10mm inset shelf panel

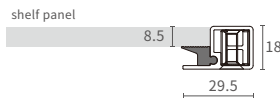
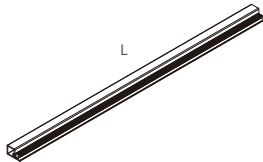

Model No.	L (Length)
L45-CB8	414mm
L60-CB8	564mm
L80-CB8	764mm
L90-CB8	864mm
L120-CB8	1164mm

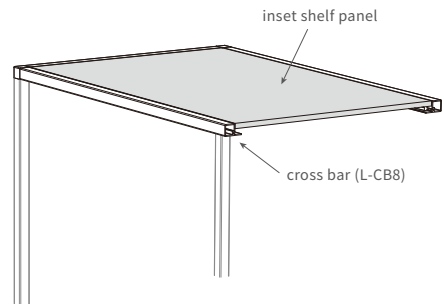

L-CB5 Shelf panel cross bar

*5.5mm inner depth, for 5 & 6mm tempered glass

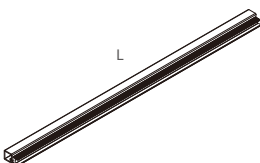

Model No.	L (Length)
L45-CB5	414mm
L60-CB5	564mm
L80-CB5	764mm
L90-CB5	864mm
L120-CB5	1164mm

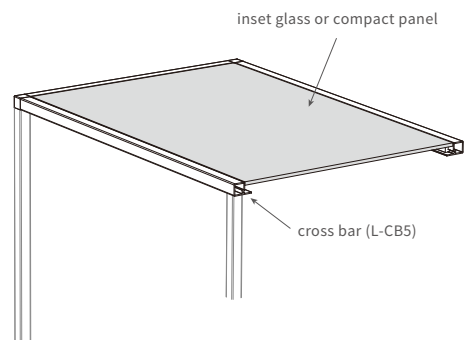

CUBE18 Frame System in kitchen

L Cube Cross Bar

L-SH Cross bar

*Screw fixing for inset or overlay shelf panel and wooden box / tray

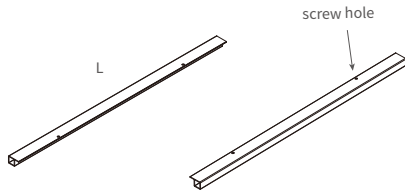

Model No.	L (Length)
L45-SH	414mm
L60-SH	564mm
L80-SH	764mm
L90-SH	864mm
L120-SH	1164mm

1) Inset shelf fixing

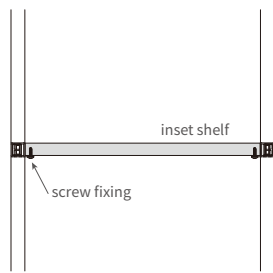

2) Screw fixing under cabinet / wooden case

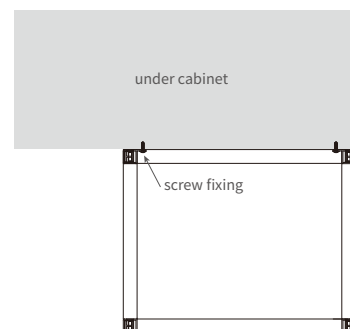
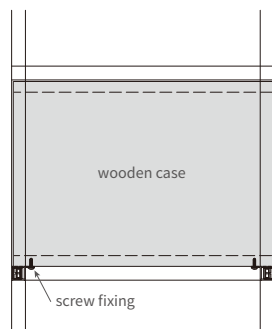

L-CB Cross bar

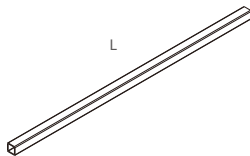

Model No.	L (Length)
L45-CB	414mm
L60-CB	564mm
L80-CB	764mm
L90-CB	864mm
L120-CB	1164mm

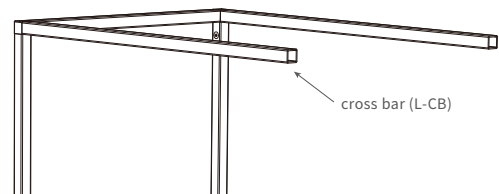

CUBE18 Frame System in kitchen

L Cube Cross Bar

L-CB16T L Top-Fixing Shelf Panel Cross bar

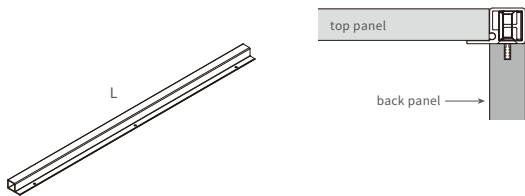

Model No.	L (Length)
L45-CB16T	414mm
L60-CB16T	564mm
L80-CB16T	764mm
L90-CB16T	864mm
L120-CB16T	1164mm

L-CB16I Vertical-T Fixing Shelf Panel Cross bar

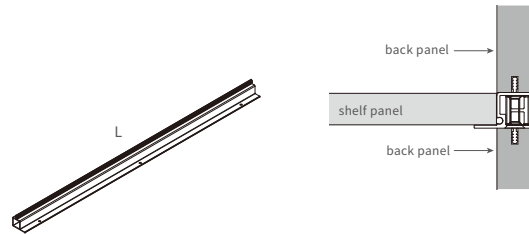

Model No.	L (Length)
L45-CB16I	414mm
L60-CB16I	564mm
L80-CB16I	764mm
L90-CB16I	864mm
L120-CB16I	1164mm

L-CB16B L Bottom-Fixing Shelf Panel Cross bar

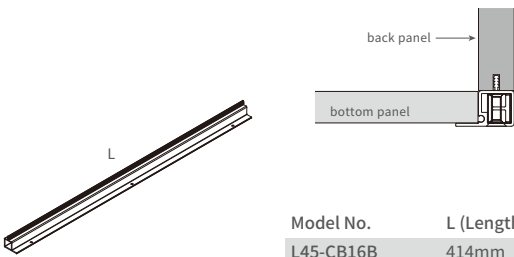

Model No.	L (Length)
L45-CB16B	414mm
L60-CB16B	564mm
L80-CB16B	764mm
L90-CB16B	864mm
L120-CB16B	1164mm

Back / Side Panel or Sliding Door Panel

- * Laminated chipboard, 18mm thickness
- * PL= L-1mm
- * PH= H-1mm

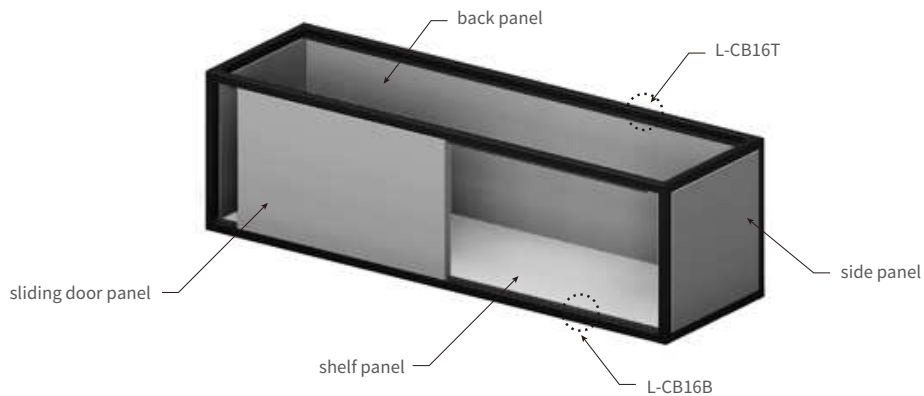
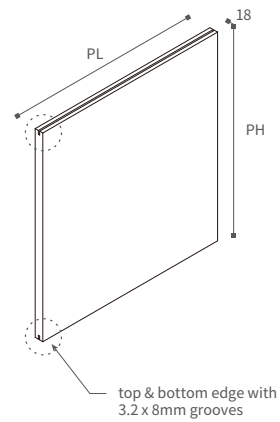

CUBE18 Frame System in kitchen

L-DL18

CUBE18 Aluminium Shell

*To be mounted under or inside CUBE18, fits DL18 LED light

*Finishes: black (NK), matt silver (NA) & inox (ABN)

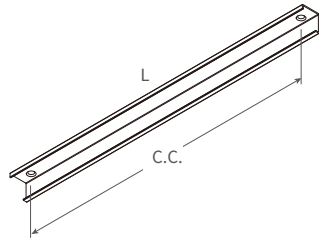
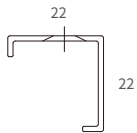

Model No.	Length (L)	Center to center (C.C.)
L40-DL18	354mm	324mm
L45-DL18	404mm	374mm
L60-DL18	554mm	524mm
L80-DL18	754mm	724mm
L90-DL18	854mm	824mm
L100-DL18	954mm	924mm
L120-DL18	1154mm	1124mm

A) Under CUBE18 frame

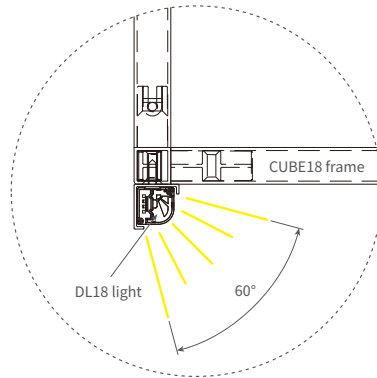
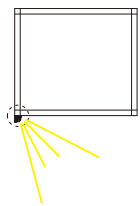

B) Inside CUBE18 frame

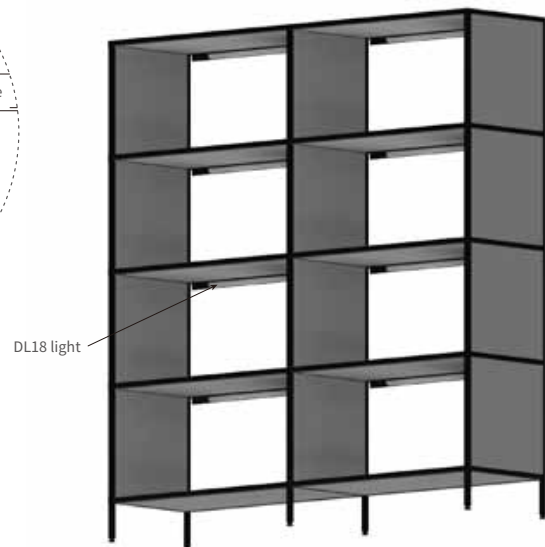
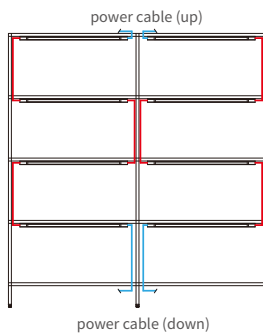
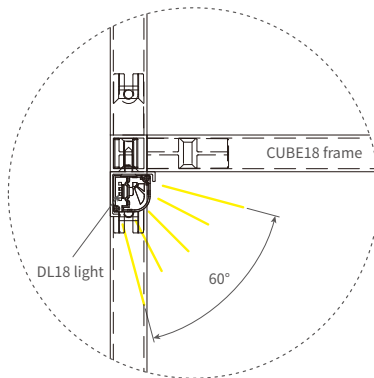
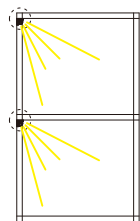

CUBE18 Frame System in kitchen

UC-DL18

Under-Cabinet Aluminium Shell

- * To be mounted under or inside shelf, cabinet and drawer, fits DL18 LED light
- * Finishes: black (NK), matt silver (NA) & inox (ABN)

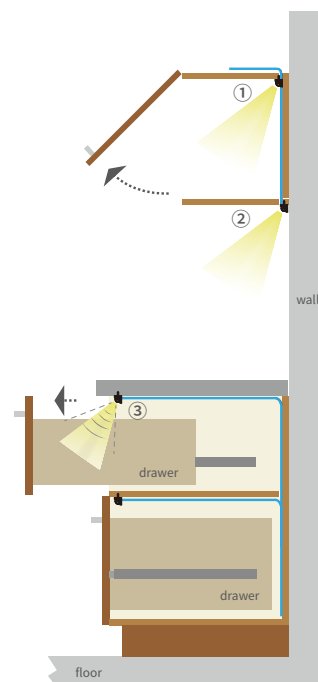
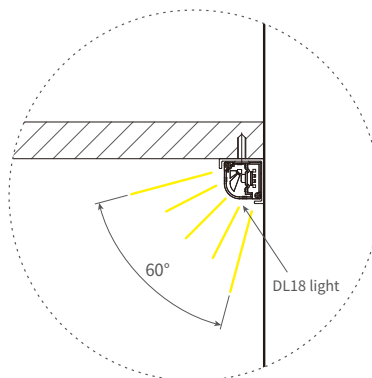
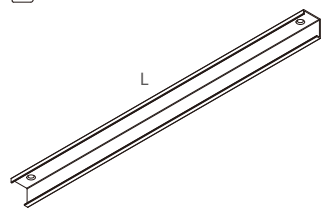
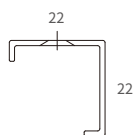

Model No.	Length (L)	LED linear light
UC-DL18-38	380mm	DL18-1 (293mm L.)
UC-DL18-66	660mm	DL18-2 (578mm L.)

DL18 LED Linear Light, 24 Vdc

- * Color temperature: 3,000K / CRI90 & 5,700K / CRI90



- ① Inside cabinet
- ② Under cabinet
- ③ Inside drawer
- ④ Inside wardrobe

CS24IR DC Driver, with sensor switch

- * Hand-waving on/off switch
- * Mounted under wooden shelf



CS24PIR DC Driver, PIR motion detector

- * 60 seconds auto-off
- * Maximum 4 meters detecting range
- * Mounted under wooden shelf



CUBE18 Frame System in kitchen

Flat Pack of CUBE18 Cube Shelf

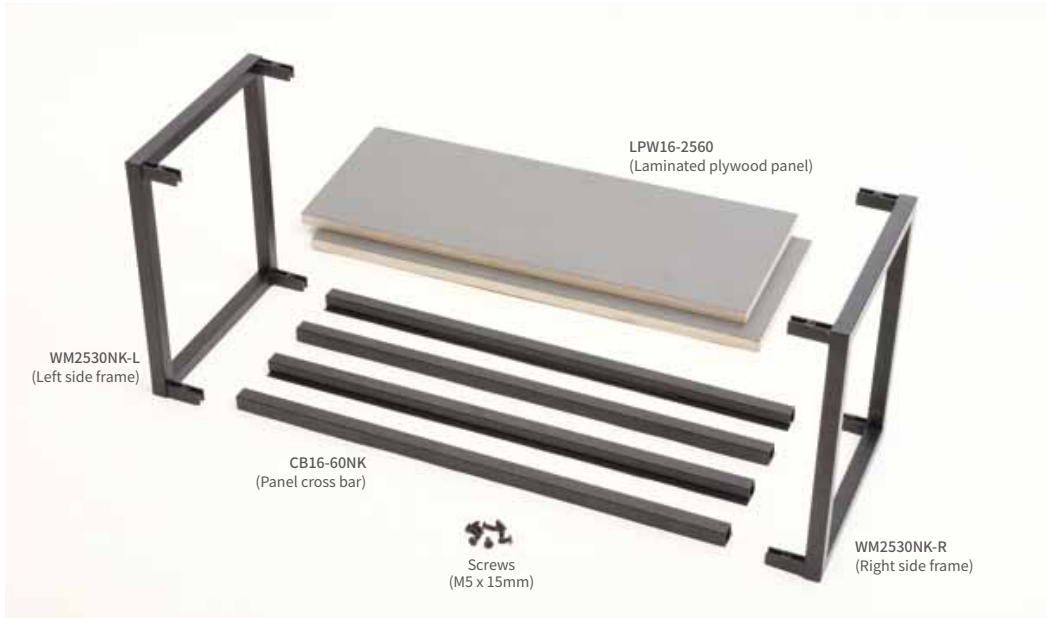

Box 1A
*1 left, 1 right cube frame & cover caps in one box

Left cube frame Right cube frame

Cover cap

box 1A

Box 1B
*1 extension cube frame & cover caps in box

Extension cube frame

Cover cap

box 1B

Box 2
*4 pcs cross bars, 8 pcs connecting screws and 1 pc M3 hex key

cross bar (4 pcs)

M5 screw (8 pcs)

M3 hex key

box 2

Box 3
*2 pcs inset shelf panels

box 3

Index

Model	Page	Model	Page	Model	Page	Model	Page
CM4034-2HE	12	FSR45HE-248	14	L80-CB5	25	SSL60L-198	15
CM4034-2SD	12	FSR45SD-148	14	L80-CB8	25	SSL60L-248	15
CM4034-HE	11	FSR45SD-198	14	L80-DL18	28	SSL60R-148	15
CM4034-SD	11	FSR45SD-248	14	L80-SH	26	SSL60R-198	15
CM4534-2HE	12	FSR50HE-148	14	L90-CB	26	SSL60R-248	15
CM4534-2SD	12	FSR50HE-198	14	L90-CB16	25	TSL40SD-148	16
CM4534-HE	11	FSR50HE-248	14	L90-CB16B	27	TSL40SD-198	16
CM4534-SD	11	FSR50SD-148	14	L90-CB16I	27	TSL40SD-248	16
CM5634-2HE	12	FSR50SD-198	14	L90-CB16T	27	TSL45SD-148	16
CM5634-2SD	12	FSR50SD-248	14	L90-CB5	25	TSL45SD-198	16
CM5634-HE	11	FSR56HE-148	14	L90-CB8	25	TSL45SD-248	16
CM5634-SD	11	FSR56HE-198	14	L90-DL18	28	TSL50SD-148	16
CS24IR	29	FSR56HE-248	14	L90-SH	26	TSL50SD-198	16
CS24PIR	29	FSR56SD-148	14	L-Screen	24	TSL50SD-248	16
DC700	23	FSR56SD-198	14	M10 Bolt	17	TSL56SD-148	16
DI-UHK65-5DB	23	FSR56SD-248	14	PLD200	23	TSL56SD-198	16
DL18	29	FSR60HE-148	14	PS	17	TSL56SD-248	16
DSF2511-HE	9	FSR60HE-198	14	RF2-4590	8	TSL60SD-148	16
DSF2511-SD	9	FSR60HE-248	14	RF2-6080	8	TSL60SD-198	16
DSF2544-HE	9	FSR60SD-148	14	RM-BF	17	TSL60SD-248	16
DSF2544-SD	9	FSR60SD-198	14	RM-DF40	17	UC-DL18-38	29
DSF40HE-162	13	FSR60SD-248	14	RM-DF50	17	UC-DL18-66	29
DSF40HE-212	13	L100-DL18	28	RM-DF60	17	WM11DF-HE	5
DSF40HE-262	13	L120-CB	26	RM-IP2	22	WM11DF-SD	5
DSF40SD-162	13	L120-CB16	25	RM-IP3	22	WM12W	23
DSF40SD-212	13	L120-CB16B	27	RM-SC2-HE	18	WM1515CHB-HE	7
DSF40SD-262	13	L120-CB16I	27	RM-SC2-SD	18	WM1515CHB-L	7
DSF45HE-162	13	L120-CB16T	27	RM-SC2P-HE	19	WM1515CHB-R	7
DSF45HE-212	13	L120-CB5	25	RM-SC2P-SD	19	WM1515CHBP-L	7
DSF45HE-262	13	L120-CB8	25	RM-SC3-HE	20	WM1515CHBP-R	7
DSF45SD-162	13	L120-DL18	28	RM-SC3-SD	20	WM1520C-HE	6
DSF45SD-212	13	L120-SH	26	RM-SC3P-HE	21	WM1520C-L	6
DSF45SD-262	13	L25-CB16	3, 4	RM-SC3P-SD	21	WM1520C-R	6
DSF50HE-162	13	L25-CB5	3, 4	SQ18AH	5	WM1520CP-L	6
DSF50HE-212	13	L25-CB8	3, 4	SSL40L-148	15	WM1520CP-R	6
DSF50HE-262	13	L40-DL18	28	SSL40L-198	15	WM15DF-HE	6
DSF50SD-162	13	L45-CB	26	SSL40L-248	15	WM15DF-SD	6
DSF50SD-212	13	L45-CB16	25	SSL40R-148	15	WM2530-2HE	4
DSF50SD-262	13	L45-CB16B	27	SSL40R-198	15	WM2530-2L	4
DSF56HE-162	13	L45-CB16I	27	SSL40R-248	15	WM2530-2R	4
DSF56HE-212	13	L45-CB16T	27	SSL45L-148	15	WM2530HB-HE	7
DSF56HE-262	13	L45-CB5	25	SSL45L-198	15	WM2530HB-L	7
DSF56SD-162	13	L45-CB8	25	SSL45L-248	15	WM2530HB-R	7
DSF56SD-212	13	L45-DL18	28	SSL45R-148	15	WM2530HBP-L	7
DSF56SD-262	13	L45-SH	26	SSL45R-198	15	WM2530HBP-R	7
DSF60HE-162	13	L60-CB	26	SSL45R-248	15	WM2530-HE	3
DSF60HE-212	13	L60-CB16	25	SSL50L-148	15	WM2530-L	3
DSF60HE-262	13	L60-CB16B	27	SSL50L-198	15	WM2530-R	3
DSF60SD-162	13	L60-CB16I	27	SSL50L-248	15	WM2530LC	3
DSF60SD-212	13	L60-CB16T	27	SSL50R-148	15	WM2530LC-2	4
DSF60SD-262	13	L60-CB5	25	SSL50R-198	15	WM2530P-L	3
FSR40HE-148	14	L60-CB8	25	SSL50R-248	15	WM2530P-R	3
FSR40HE-198	14	L60-DL18	28	SSL56L-148	15	WM2530P-2L	4
FSR40HE-248	14	L60-SH	26	SSL56L-198	15	WM2530P-2R	4
FSR40SD-148	14	L80-CB	26	SSL56L-248	15	WM-2543IP	8
FSR40SD-198	14	L80-CB16	25	SSL56R-148	15	WM-2576IP	8
FSR40SD-248	14	L80-CB16B	27	SSL56R-198	15	WM-3043IP	8
FSR45HE-148	14	L80-CB16I	27	SSL56R-248	15	WM-3076IP	8
FSR45HE-198	14	L80-CB16T	27	SSL60L-148	15		

Алматы (7273)495-231
Ангарск (3955)60-70-56
Архангельск (8182)63-90-72
Астрахань (8512)99-46-04
Барнаул (3852)73-04-60
Белгород (4722)40-23-64
Благовещенск (4162)22-76-07
Брянск (4832)59-03-52
Владивосток (423)249-28-31
Владикавказ (8672)28-90-48
Владимир (4922)49-43-18
Волгоград (844)278-03-48
Вологда (8172)26-41-59
Воронеж (473)204-51-73
Екатеринбург (343)384-55-89

Иваново (4932)77-34-06
Ижевск (3412)26-03-58
Иркутск (395)279-98-46
Казань (843)206-01-48
Калининград (4012)72-03-81
Калуга (4842)92-23-67
Кемерово (3842)65-04-62
Киров (8332)68-02-04
Коломна (4966)23-41-49
Кострома (4942)77-07-48
Краснодар (861)203-40-90
Красноярск (391)204-63-61
Курск (4712)77-13-04
Курган (3522)50-90-47
Липецк (4742)52-20-81

Магнитогорск (3519)55-03-13
Москва (495)268-04-70
Мурманск (8152)59-64-93
Набережные Челны (8552)20-53-41
Нижний Новгород (831)429-08-12
Новокузнецк (3843)20-46-81
Ноябрьск (3496)41-32-12
Новосибирск (383)227-86-73
Омск (3812)21-46-40
Орел (4862)44-53-42
Оренбург (3532)37-68-04
Пенза (8412)22-31-16
Петрозаводск (8142)55-98-37
Псков (8112)59-10-37

Пермь (342)205-81-47
Ростов-на-Дону (863)308-18-15
Рязань (4912)46-61-64
Самара (846)206-03-16
Саранск (8342)22-96-24
Санкт-Петербург (812)309-46-40
Саратов (845)249-38-78
Севастополь (8692)22-31-93
Симферополь (3652)67-13-56
Смоленск (4812)29-41-54
Сочи (862)225-72-31
Ставрополь (8652)20-65-13
Сургут (3462)77-98-35
Сыктывкар (8212)25-95-17
Тамбов (4752)50-40-97

Тверь (4822)63-31-35
Тольятти (8482)63-91-07
Томск (3822)98-41-53
Тула (4872)33-79-87
Тюмень (3452)66-21-18
Ульяновск (8422)24-23-59
Улан-Удэ (3012)59-97-51
Уфа (347)229-48-12
Хабаровск (4212)92-98-04
Чебоксары (8352)28-53-07
Челябинск (351)202-03-61
Череповец (8202)49-02-64
Чита (3022)38-34-83
Якутск (4112)23-90-97
Ярославль (4852)69-52-93

Россия +7(495)268-04-70

Казахстан +7(7172)727-132

Киргизия +996(312)96-26-47

www.fourwinds.nt-rt.ru | | fse@nt-rt.ru