

Алматы (7273)495-231	Иваново (4932)77-34-06	Магнитогорск (3519)55-03-13	Пермь (342)205-81-47	Тверь (4822)63-31-35
Ангарск (3955)60-70-56	Ижевск (3412)26-03-58	Москва (495)268-04-70	Ростов-на-Дону (863)308-18-15	Тольятти (8482)63-91-07
Архангельск (8182)63-90-72	Иркутск (395)279-98-46	Мурманск (8152)59-64-93	Рязань (4912)46-61-64	Томск (3822)98-41-53
Астрахань (8512)99-46-04	Казань (843)206-01-48	Набережные Челны (8552)20-53-41	Самара (846)206-03-16	Тула (4872)33-79-87
Барнаул (3852)73-04-60	Калининград (4012)72-03-81	Нижний Новгород (831)429-08-12	Саранск (8342)22-96-24	Тюмень (3452)66-21-18
Белгород (4722)40-23-64	Калуга (4842)92-23-67	Новокузнецк (3843)20-46-81	Санкт-Петербург (812)309-46-40	Ульяновск (8422)24-23-59
Благовещенск (4162)22-76-07	Кемерово (3842)65-04-62	Ноябрьск (3496)41-32-12	Саратов (845)249-38-78	Улан-Удэ (3012)59-97-51
Брянск (4832)59-03-52	Киров (8332)68-02-04	Новосибирск (383)227-86-73	Севастополь (8692)22-31-93	Уфа (347)229-48-12
Владивосток (423)249-28-31	Коломна (4966)23-41-49	Омск (3812)21-46-40	Симферополь (3652)67-13-56	Хабаровск (4212)92-98-04
Владикавказ (8672)28-90-48	Кострома (4942)77-07-48	Орел (4862)44-53-42	Смоленск (4812)29-41-54	Чебоксары (8352)28-53-07
Владимир (4922)49-43-18	Краснодар (861)203-40-90	Оренбург (3532)37-68-04	Сочи (862)225-72-31	Челябинск (351)202-03-61
Волгоград (844)278-03-48	Красноярск (391)204-63-61	Пенза (8412)22-31-16	Ставрополь (8652)20-65-13	Череповец (8202)49-02-64
Вологда (8172)26-41-59	Курск (4712)77-13-04	Петрозаводск (8142)55-98-37	Сургут (3462)77-98-35	Чита (3022)38-34-83
Воронеж (473)204-51-73	Курган (3522)50-90-47	Псков (8112)59-10-37	Сыктывкар (8212)25-95-17	Якутск (4112)23-90-97
Екатеринбург (343)384-55-89	Липецк (4742)52-20-81		Тамбов (4752)50-40-97	Ярославль (4852)69-52-93

Россия +7(495)268-04-70

Казахстан +7(7172)727-132

Киргизия +996(312)96-26-47

www.fourwinds.nt-rt.ru | fse@nt-rt.ru

Технические характеристики на каркасные системы (столы, стулья, полочки, скамейки) компании **Four Winds**

Виды товаров: ножки каркасные, каркасы настенных полок, каркасы подставки под телевизор, ножки шкафа и дивана, поперечные балки, каркасы журнальных столиков, отдельно стоящие каркасные перегородки для стола, каркасные крестовые подставки, каркасы для табуреток, каркасы для барных стульев, каркасы для скамеек и др.

FRAME Stand System

High-grade aluminium plus precision welding and quality powder coating

框型桌腳, 鋁合金精密焊接, 粉體塗裝上色

Color options

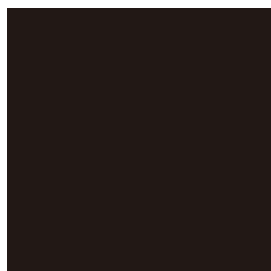

Black (NK)

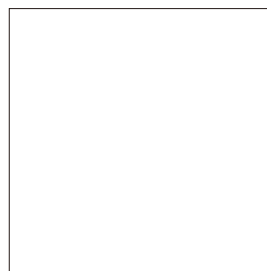

White (WT)



Antracite (HT8251)



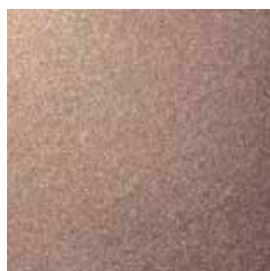

Matt silver (H28496)







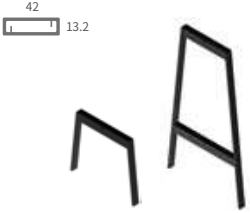

Dark bronzed (E38260)



FRAME Stand System

Table Frame Legs

AFT4	UFT4	FLT4-CB (Cross Beam)
		 <p style="text-align: right;">page 6 ~ 10</p>



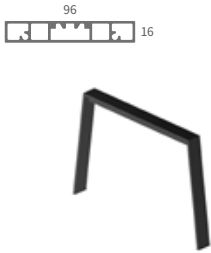













DFT6	FLT6-CB (Cross Beam)
	 <p style="text-align: right;">page 11 ~ 12</p>

AFT7	UFT7	DFT7	FLT80-7CB (Cross Beam)
			 <p style="text-align: right;">page 13 ~ 17</p>

AFT9	DFT9	FLT80-8CB (Cross Beam)
		 <p style="text-align: right;">page 18</p>



FRAME Stand System

Table Frame Legs





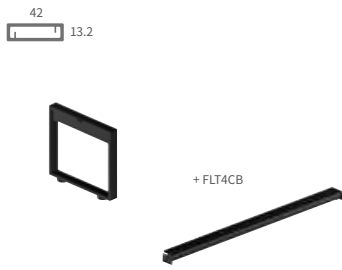

DFT6-XW		DFT9-XW	
  page 19		  page 20	
AFT4-XW	AFT6-XW	AFT9-XW	
  page 21	  page 22	  page 22	
AFT6-TW	AFT6-WW	FLT6-WSH	
<p><i>Console table</i></p>   <p><i>Floorstanding</i></p>	  <p><i>Wall-mounted</i></p>	  <p><i>Wall-mounted</i></p>	
page 23 ~ 24			

FRAME Stand System

TV Stand Frame, Cabinet & Sofa Feet

DFT4-EW-32	DFT4-CW-24	BFT4-CW-17
<p><i>TV Stand frame</i></p>  <p>42 13.2</p> <p>page 26</p>	<p><i>Cabinet & Sofa Feet</i></p>  <p>page 27</p>	<p><i>Cabinet & Sofa Feet</i></p>  <p>page 28</p>

Stool, Chair & Bench Frames

Stool Frame	Chair Frame	Bench Frame
<p><i>ST30 / ST35 / ST45</i></p> 	<p><i>CH35 / CH45</i></p> 	<p><i>ABH30 / ABH35</i></p> 
<p><i>HST30 / HST35 / HST45</i></p>  <p>page 29 ~ 31</p>	<p><i>HCH35 / HCH45</i></p>  <p>page 32 ~ 33</p>	<p><i>DBH40</i></p>  <p>page 34 ~ 36</p>

AFT4 Frame Table Leg

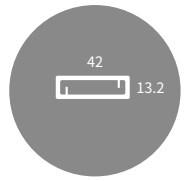

AFT4-EW-41
Frame Table Leg
*Height: 410mm

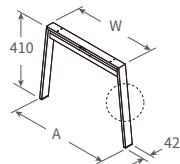

Model No.	W	A
AFT4-EW30-41	296	381
AFT4-EW35-41	346	431
AFT4-EW40-41	396	481
AFT4-EW45-41	446	531

AFT4-EW-71
Frame Table Leg
*Height: 710mm

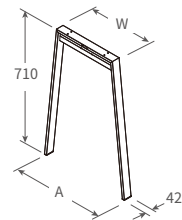

Model No.	W	A
AFT4-EW30-71	296	444
AFT4-EW35-71	346	494
AFT4-EW40-71	396	544
AFT4-EW45-71	446	594

AFT4-HW-85
Frame High Leg
*Height: 850mm

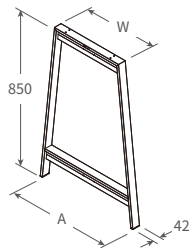

Model No.	W	A
AFT4-HW30-85	296	472
AFT4-HW35-85	346	522
AFT4-HW40-85	396	571
AFT4-HW45-85	446	622

AFT4-HW-100
Frame High Leg
*Height: 1000mm

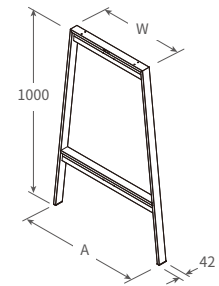

Model No.	W	A
AFT4-HW30-100	296	503
AFT4-HW35-100	346	553
AFT4-HW40-100	396	603
AFT4-HW45-100	446	653

UFT4 Frame Table Leg

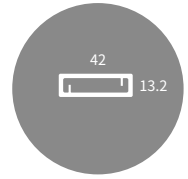

UFT4-EW-41
Frame Table Leg
*Height: 410mm

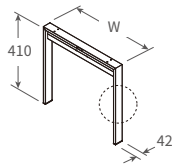

Model No.	W
UFT4-EW40-41	396
UFT4-EW45-41	446
UFT4-EW60-41	596

UFT4-EW-71
Frame Table Leg
*Height: 710mm

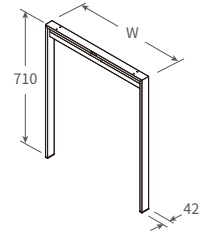

Model No.	W
UFT4-EW40-71	396
UFT4-EW45-71	446
UFT4-EW60-71	596

UFT4-HW-85
Frame High Leg
*Height: 850mm

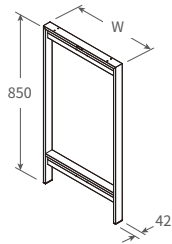

Model No.	W
UFT4-HW40-85	396
UFT4-HW45-85	446
UFT4-HW60-85	596

UFT4-HW-100
Frame High Leg
*Height: 1000mm

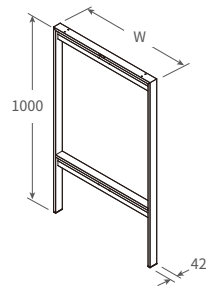

Model No.	W
UFT4-HW40-100	396
UFT4-HW45-100	446
UFT4-HW60-100	596

FLT4-CB Cross Beam

*FLT4-CB
Cross Beam (Supporter)*

*Aluminium extrusion cross bar with 2 zamak end connectors

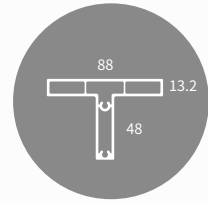
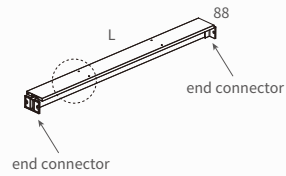

Model No.	L
FLT4-CB60	516
FLT4-CB80	716
FLT4-CB100	916
FLT4-CB120	1116
FLT4-CB140	1316
FLT4-CB160	1516

Frame Table Leg, with 1 cross beam

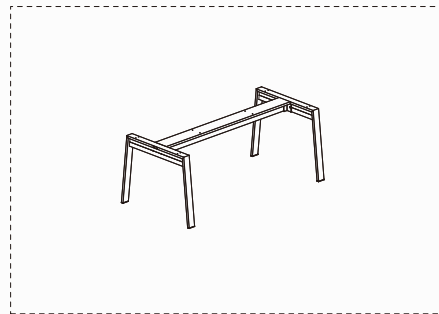
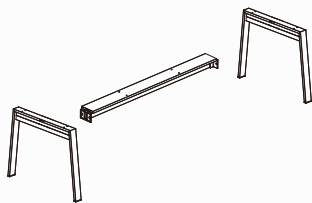

Frame High Leg, with 2 cross beams

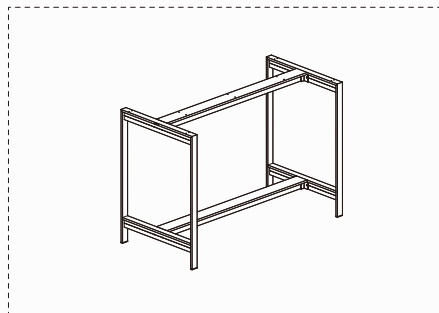
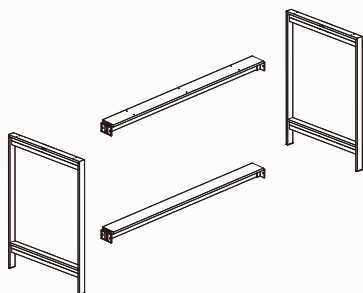

AFT4 Frame Table Leg

AFT4 Office Table Frame

Including 2 x AFT4-EW45-71 + 1 x FLT4-CB100

Dimensions: (L) 1000 x (W) 446 / 531 x (H) 710mm

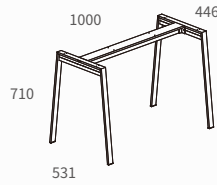

AFT4 High Bar Table Frame

Including 2 x AFT4-HW35-100 + 2 x FLT4-CB100

Dimensions: (L) 1000 x (W) 346 / 553 x (H) 1000mm

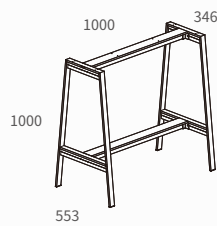

UFT4 Frame Table Leg

UFT4 Coffee Table Frame

Including 2 x UFT4-EW45-41 + 1 x FLT4-CB80

Dimensions: (L) 800 x (W) 446 x (H) 410mm

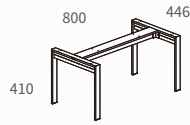

UFT4 High Working Table Frame

Including 2 x UFT4-HW60-85 + 2 x FLT4-CB120

Dimensions: (L) 1200 x (W) 596 x (H) 850mm

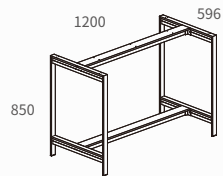

DFT6-EW & HW Frame Table Leg

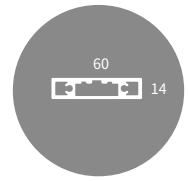

DFT6-EW40
Frame Table Leg
*Width: 396mm

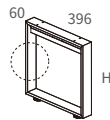

Model No.	H
DFT6-EW40-32	320
DFT6-EW40-41	410
DFT6-EW40-56	560
DFT6-EW40-71	710

DFT6-EW45
Frame Table Leg
*Width: 446mm

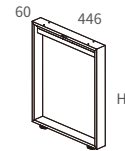

Model No.	H
DFT6-EW45-32	320
DFT6-EW45-41	410
DFT6-EW45-56	560
DFT6-EW45-71	710

DFT6-EW60
Frame Table Leg
*Width: 596mm

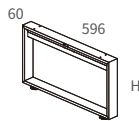

Model No.	H
DFT6-EW60-32	320
DFT6-EW60-41	410
DFT6-EW60-56	560
DFT6-EW60-71	710

DFT6-EW80
Frame Table Leg
*Width: 796mm

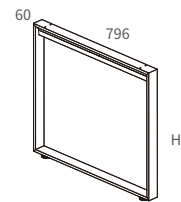

Model No.	H
DFT6-EW80-32	320
DFT6-EW80-41	410
DFT6-EW80-56	560
DFT6-EW80-71	710

DFT6-HW45
Frame High Leg
*Width: 446mm

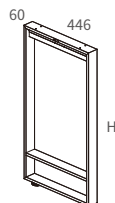

Model No.	H
DFT6-HW45-85	850
DFT6-HW45-100	1000

DFT6-HW60
Frame High Leg
*Width: 596mm

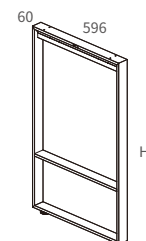

Model No.	H
DFT6-HW60-85	850
DFT6-HW60-100	1000

DFT6-EW Frame Table Leg

FLT6-CB
Cross Beam (Supporter)

*Aluminium extrusion cross bar with 2 zamak end connectors

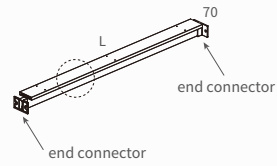

Model No.	L
FLT6-CB100	876
FLT6-CB120	1076
FLT6-CB140	1276
FLT6-CB160	1476

DFT6 Coffee Table Frame

Size: (L) 1,196 x (W) 596 x (H) 410mm

Including 2 x DFT6-EW60-41 + 1 x FLT6-CB120

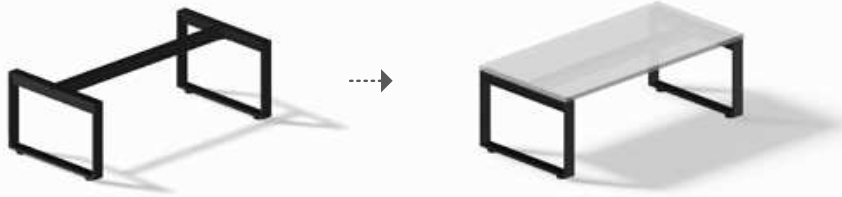

DFT6 Dining Table Frame

Size: (L) 1,596 x (W) 796 x (H) 710mm

Including 2 x DFT6-EW80-71 + 1 x FLT6-CB160

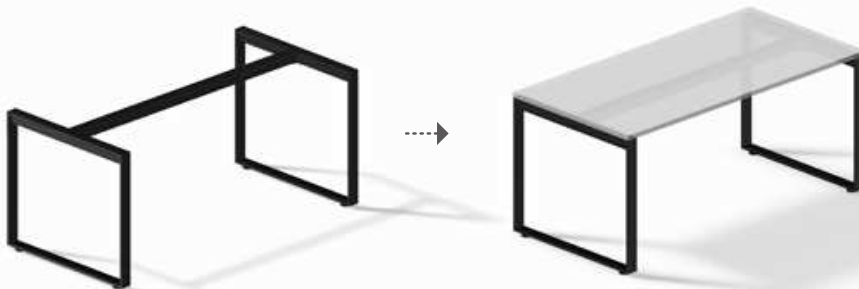

DFT6 Working Table Frame

Size: (L) 1,136 x (W) 596 x (H) 1000mm

Including 1 x DFT6-HW60-100 + 2 x FLT6-CB120

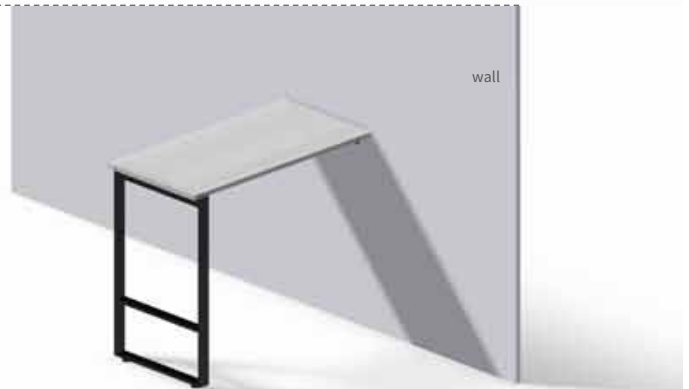
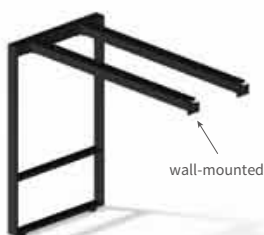

AFT7-EW & HW Frame Table Leg

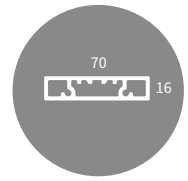

AFT7-EW-71
 Frame Table Leg
 *Height: 710mm

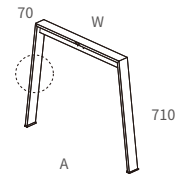
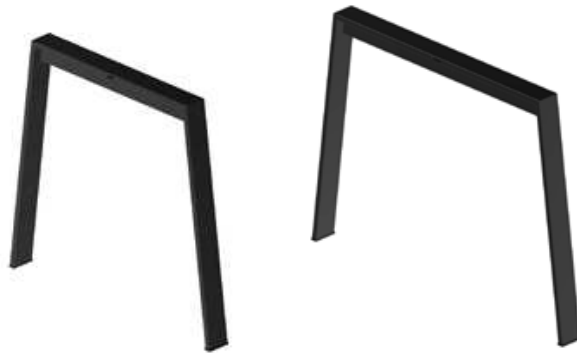

Model No.	W	A
AFT7-EW45-71	446	619
AFT7-EW60-71	596	769
AFT7-EW70-71	700	869
AFT7-EW80-71	796	970

AFT7-HW-85
 Frame High Leg
 *Height: 850mm

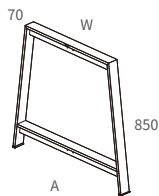

Model No.	W	A
AFT7-HW45-85	446	651
AFT7-HW60-85	596	801
AFT7-HW70-85	700	901
AFT7-HW80-85	796	1000

AFT7-HW-100
 Frame High Leg
 *Height: 1000mm

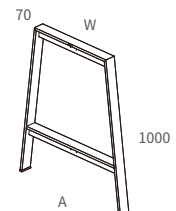

Model No.	W	A
AFT7-HW45-100	446	688
AFT7-HW60-100	596	838
AFT7-HW70-100	700	938
AFT7-HW80-100	796	1039

UFT7-EW & HW Frame Table Leg

UFT7-EW-71
 Frame Table Leg
 *Height: 710mm

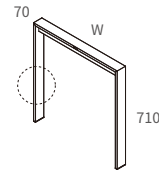
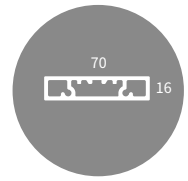

Model No.	W
UFT7-EW45-71	446
UFT7-EW60-71	596
UFT7-EW70-71	700
UFT7-EW80-71	796

UFT7-HW-85
 Frame High Leg
 *Height: 850mm

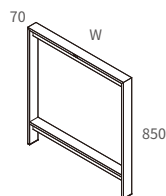

Model No.	W
UFT7-HW45-85	446
UFT7-HW60-85	596
UFT7-HW70-85	700
UFT7-HW80-85	796

UFT7-HW-100
 Frame High Leg
 *Height: 1000mm

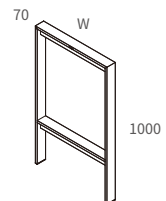
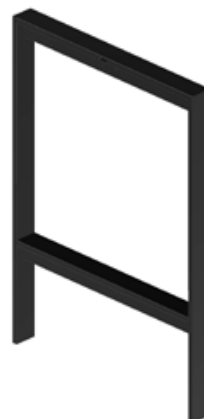

Model No.	W
UFT7-HW45-100	446
UFT7-HW60-100	596
UFT7-HW70-100	700
UFT7-HW80-100	796

DFT7-EW Frame Table Leg

DFT7-EW-71
Frame Table Leg

*Applicable to 1 top beam
*Height: 710mm

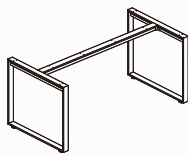
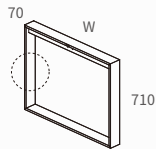
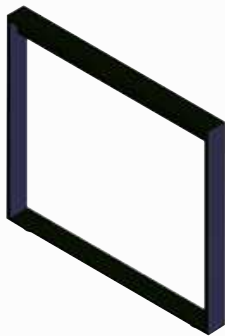

Model No.	W
DFT7-EW70-71	696
DFT7-EW80-71	796

DFT7-2EW-71
Frame Table Leg

*Applicable to 2 top beams
*Height: 710mm

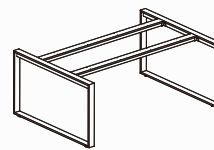
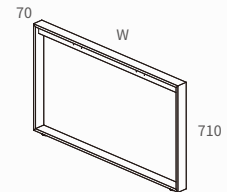
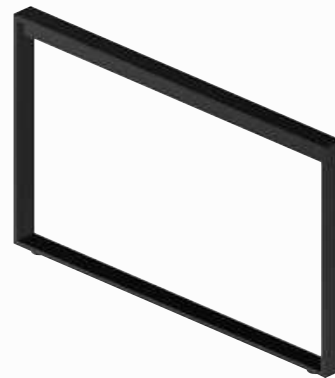

Model No.	W
DFT7-2EW120-71	1196
DFT7-2EW140-71	1396

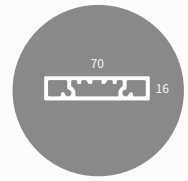

FLT80-7CB
Cross Beam (Supporter)

*Aluminium extrusion cross bar with 2 zamak end connectors

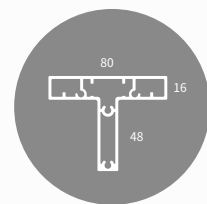
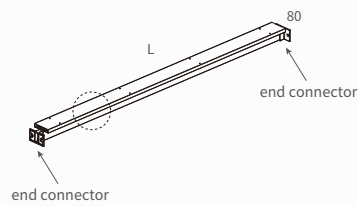

Model No.	L
FLT80-7CB110	956
FLT80-7CB130	1156
FLT80-7CB150	1356
FLT80-7CB160	1456
FLT80-7CB180	1656

AFT7, UFT7 & DFT7 Frame Table Leg

AFT7 Working Table Frame

Size: (L) 1,496 x (W) 796 x (H) 850mm
Including 2 x AFT7-HW80-85 + 2 x FLT80-7CB150



UFT7 Office Table Frame

Size: (L) 1,096 x (W) 596 x (H) 710mm
Including 2 x UFT7-EW60-71 + 1 FLT80-7CB110

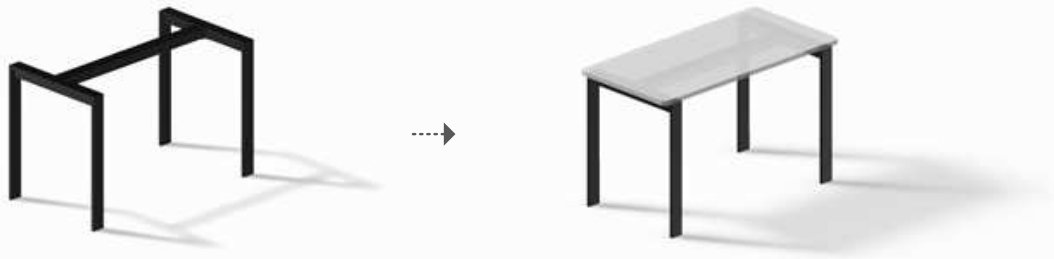

DFT7 Office Table Frame, with side table

Size: (L) 1,396 x (W) 1,396 / 696 x (H) 710mm
Including 1 x DFT7-EW140-71 + 1 x DFT7-EW70-71
+ 2 x FLT80-7CB140

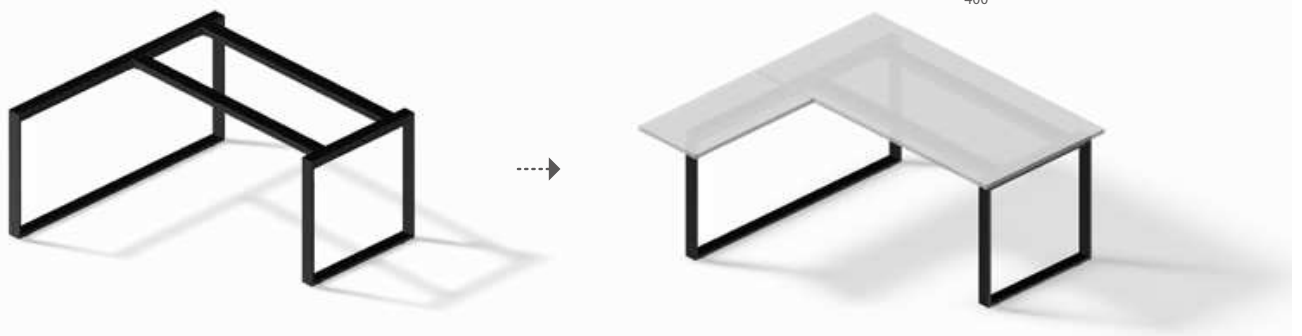
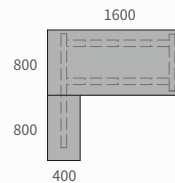
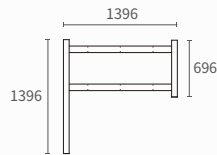

AFT7 & DFT7 Frame Table Leg

AFT7 Long Table Frame System

Size: (L) 2,122 x (W) 796 / 446 x (H) 710mm

Including 2 x AFT7-EW80-71 + 1 x AFT7-EW45-71 + 2 x FLT80-7CB110

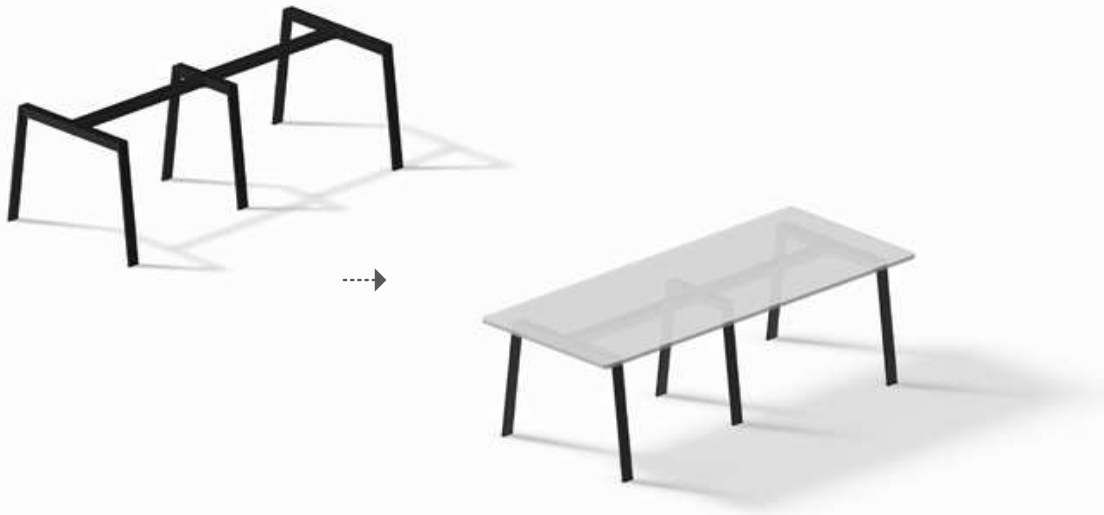

DFT7 Long Table Frame System

Size: (L) 3,122 x (W) 1,196 x (H) 710mm

Including 3 x DFT7-EW120-71 + 4 x FLT80-7CB160

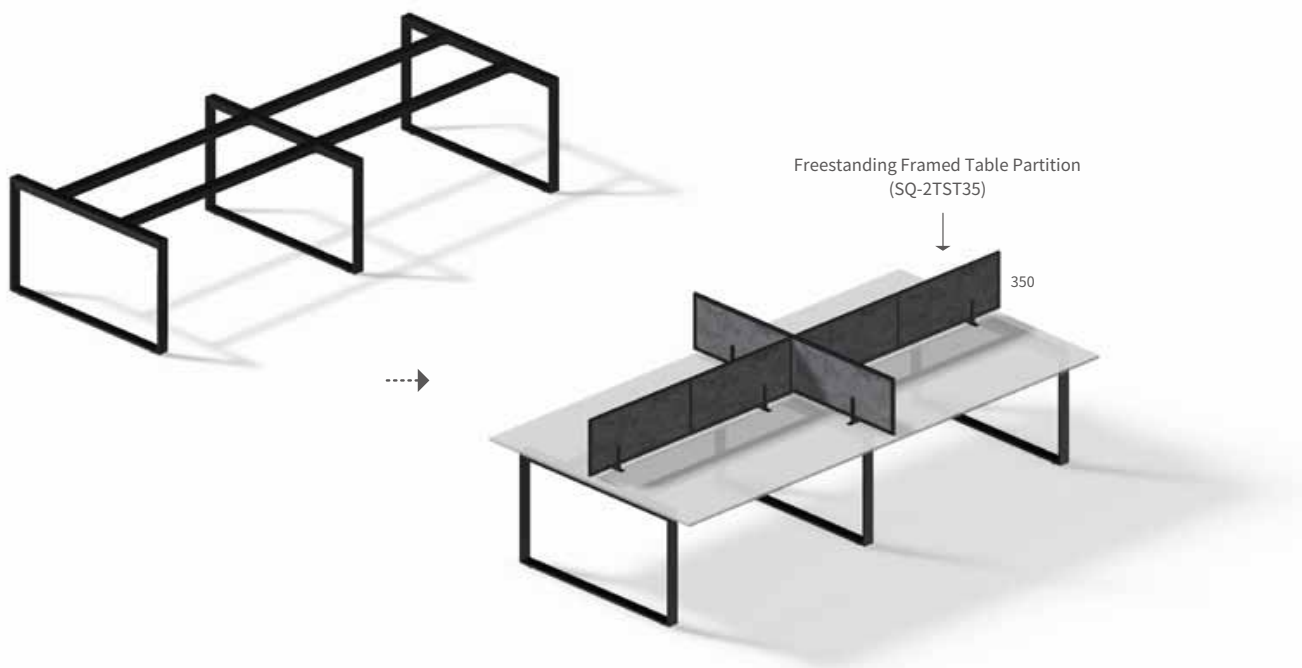

AFT9 & DFT9 Frame Table Leg

AFT9-EW90-71
Frame Table Leg

*Applicable to 2 cross beams
*Size: (W) 896 x (A) 1070 x (H) 710mm

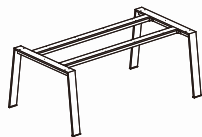
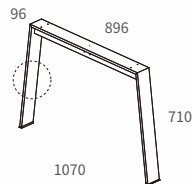

DFT9-EW100-71
Frame Table Leg

*Applicable to 2 cross beams
*Size: (W) 996 x (H) 710mm

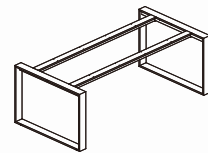
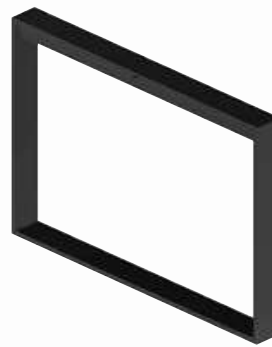
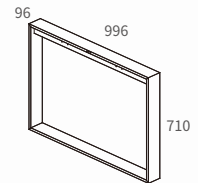
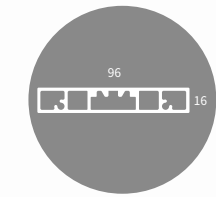

DFT9-EW120-71
Frame Table Leg

*Applicable to 2 cross beams
*Size: (W) 1196 x (H) 710mm

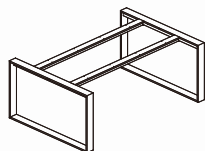
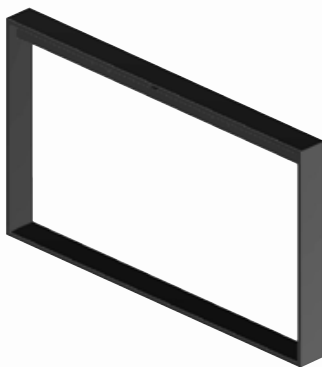
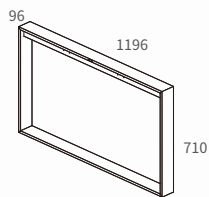

FLT80-9CB
Cross Beam (Supporter)

*Aluminium extrusion cross bar with
2 zamak end connectors

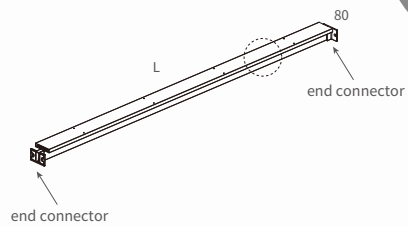
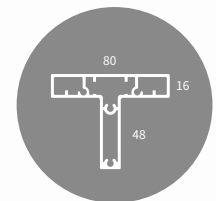

Model No.	L
FLT80-9CB180	1620
FLT80-9CB200	1820
FLT80-9CB240	2220

DFT6-XW Frame Cross Stand

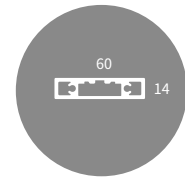
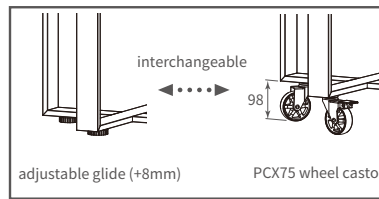

DFT6-XW45
Frame Cross Stand
*W x W: 446 x 446mm

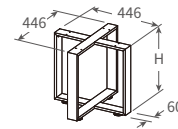

Model No.	H
DFT6-XW45-41	410
DFT6-XW45-71	710

DFT6-XW60
Frame Cross Stand
*W x W: 596 x 596mm

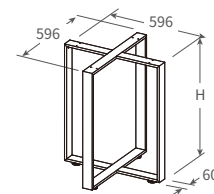

Model No.	H
DFT6-XW60-41	410
DFT6-XW60-71	710

DFT6-XW80
Frame Cross Stand
*W x W: 796 x 796mm

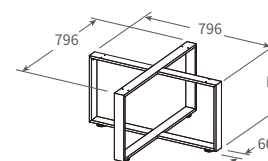

Model No.	H
DFT6-XW80-41	410
DFT6-XW80-71	710

DFT9-XW Frame Cross Stand

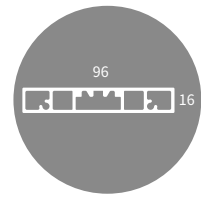
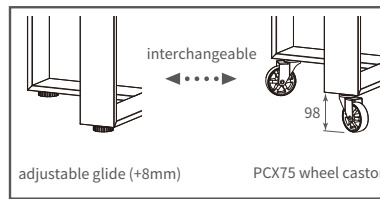

DFT9-XW50
Frame Cross Stand
*W x W: 496 x 496mm

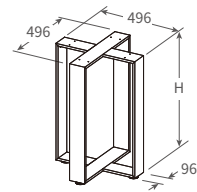

Model No.	H
DFT9-XW50-41	410
DFT9-XW50-71	710
DFT9-XW50-100	1000

DFT9-XW70
Frame Cross Stand
*W x W: 696 x 696mm

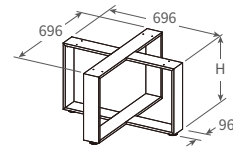

Model No.	H
DFT9-XW70-41	410
DFT9-XW70-71	710
DFT9-XW70-100	1000

DFT9-XW90
Frame Cross Stand
*W x W: 896 x 896mm

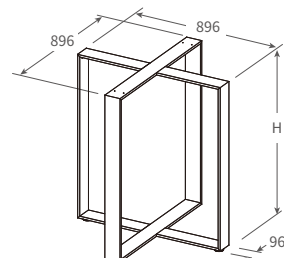

Model No.	H
DFT9-XW90-41	410
DFT9-XW90-71	710
DFT9-XW90-100	1000

AFT4-XW Frame Cross Stand

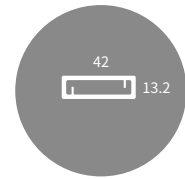

AFT4-XW35
Cross Table Leg
*W x W: 346 x 346mm

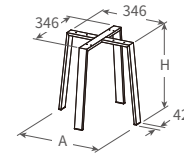

Model No.	A	H
AFT4-XW35-41	431	410
AFT4-XW35-56	462	560
AFT4-XW35-71	494	710
AFT4-XW35-85	522	850
AFT4-XW35-100	553	1000

AFT4-XW40
Cross Table Leg
*W x W: 396 x 396mm

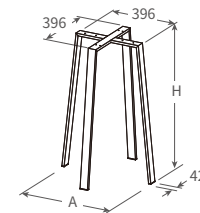

Model No.	A	H
AFT4-XW40-41	481	410
AFT4-XW40-56	512	560
AFT4-XW40-71	544	710
AFT4-XW40-85	571	850
AFT4-XW40-100	603	1000

AFT4-XW45
Cross Table Leg
*W x W: 446 x 446mm

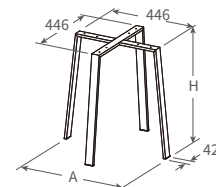

Model No.	A	H
AFT4-XW45-41	531	410
AFT4-XW45-56	562	560
AFT4-XW45-71	594	710
AFT4-XW45-85	622	850
AFT4-XW45-100	653	1000

AFT6-XW Frame Cross Stand

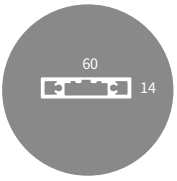

AFT6-XW60
Frame Cross Stand
*W x W: 596 x 596mm

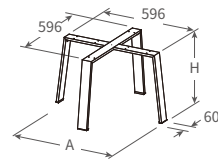

Model No.	A	H
AFT6-XW60-41	696	410
AFT6-XW60-71	769	710
AFT6-XW60-85	801	850

AFT6-XW70
Frame Cross Stand
*W x W: 700 x 700mm

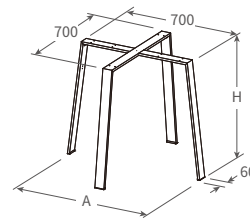

Model No.	A	H
AFT6-XW70-41	800	410
AFT6-XW70-71	869	710
AFT6-XW70-85	901	850

AFT9-XW Frame Cross Stand

AFT9-XW90
Frame Cross Stand
*W x W: 896 x 896mm

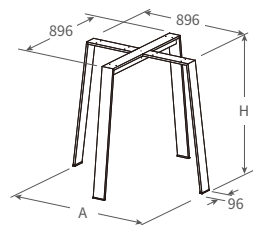
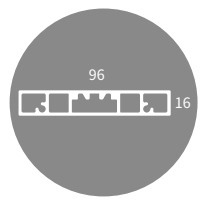

Model No.	A	H
AFT9-XW90-71	1069	710
AFT9-XW90-85	1101	850
AFT9-XW90-100	1138	1000

AFT6-TW Frame T Stand

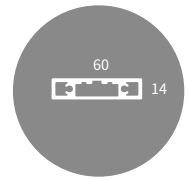

AFT6-TW60
 Frame T Stand
 *W x D: 596 x 328mm

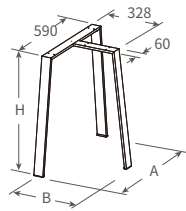

Model No.	A x B	H
AFT6-TW60-41	696x378	410
AFT6-TW60-71	769x415	710
AFT6-TW60-85	801x431	850

AFT6-TW70
 Frame T Stand
 *W x D: 700 x 380mm

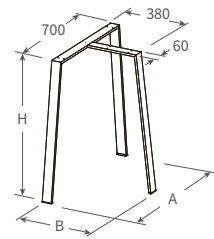

Model No.	A x B	H
AFT6-TW70-41	800x430	410
AFT6-TW70-71	869x465	710
AFT6-TW70-85	901x481	850

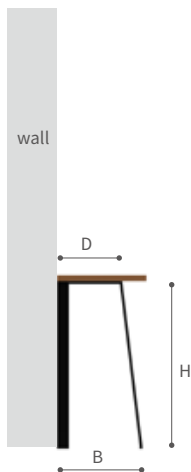

AFT6-WW & FLT60-WSH Wall-Mounted Leg

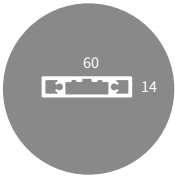

AFT6-WW
 Wall-Mounted J Leg
 *Height: 410, 700 & 850mm

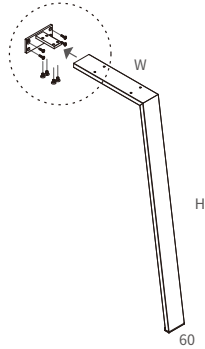

Model No.	W	H
AFT6-WW21-41	198	410
AFT6-WW21-71	198	710
AFT6-WW21-85	198	850
AFT6-WW27-41	273	410
AFT6-WW27-71	273	710
AFT6-WW27-85	273	850
AFT6-WW32-41	323	410
AFT6-WW32-71	323	710
AFT6-WW32-85	323	850

FLT60-WSH
 Wall-Mounted Shelf Support
 *Length: 210, 277 & 327mm

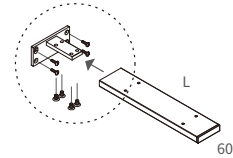

Model No.	L
FLT60-WSH21	210
FLT60-WSH27	277
FLT60-WSH32	327

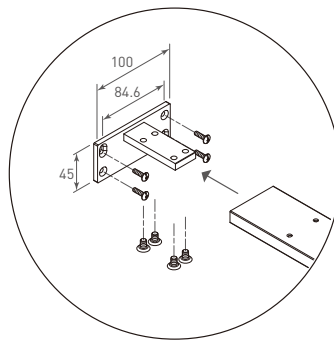

K/D Flat Pack

EW Table Leg + FLT Cross Beam



EW Table Leg (2 pcs)

FLT Cross Beam

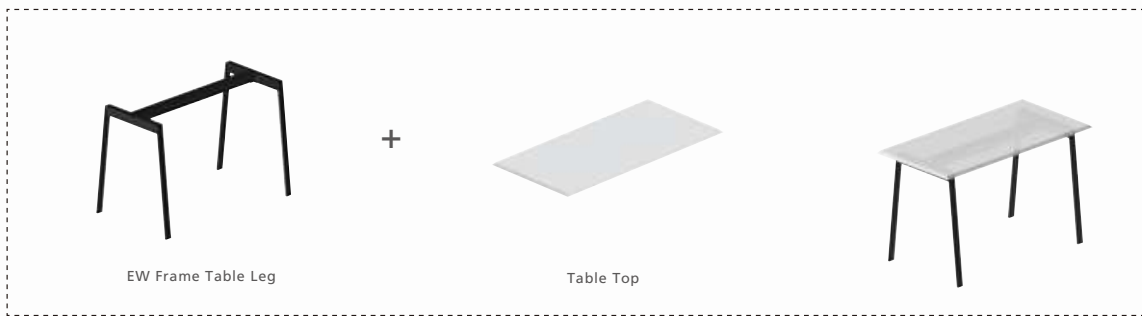

EW Frame Table Leg

Table Top

XW Table Leg | TW Table Leg



XW Table Leg (3 articles per set)



TW Table Leg (2 articles per set)



XW Frame Table Leg

Table Top

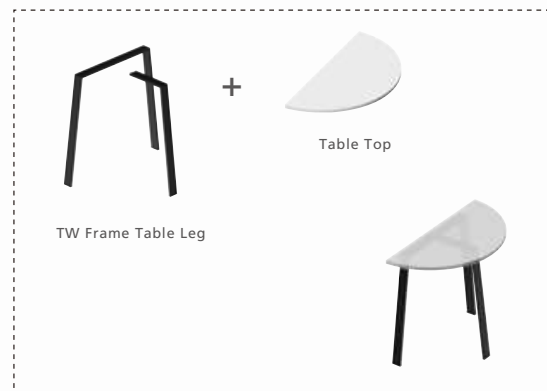

TW Frame Table Leg

Table Top

DFT4-EW-32 TV Stand Frame

**DFT4-EW-32
TV Stand Frame**

- *Height: 320mm
- *With height adjustable glides (+10 mm)

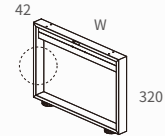
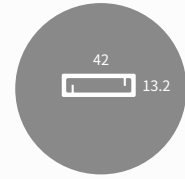
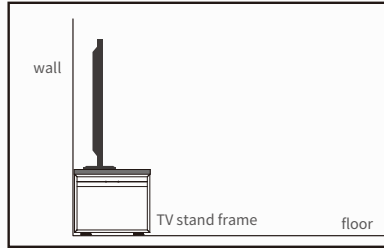

Model No.	W
DFT4-EW35-32	346
DFT4-EW40-32	396
DFT4-EW45-32	446

**FLT4-CB
Cross Beam (Supporter)**

- *Aluminium extrusion cross bar with 2 zamak end connectors

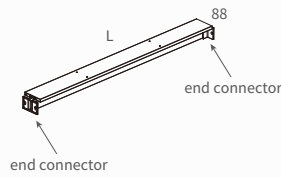

Model No.	L
FLT4-CB120	1116
FLT4-CB140	1316
FLT4-CB160	1516
FLT4-CB180	1716
FLT4-CB200	1916

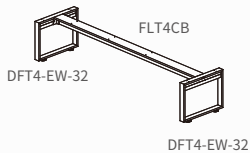

DFT4-CW Cabinet & Sofa Feet

**DFT4-CW-24
Cabinet & Sofa Feet**

- *Height: 240mm
- *With height adjustable glides (+10 mm)

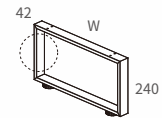
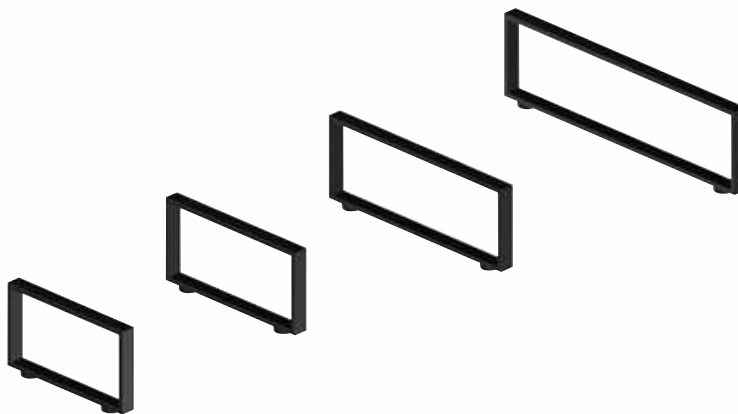
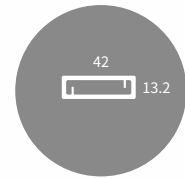
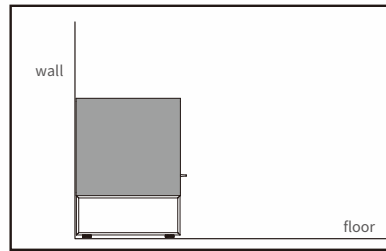

Model No.	W
DFT4-CW40-24	396
DFT4-CW45-24	446
DFT4-CW60-24	596
DFT4-CW80-24	796



DFT4-CW60-24

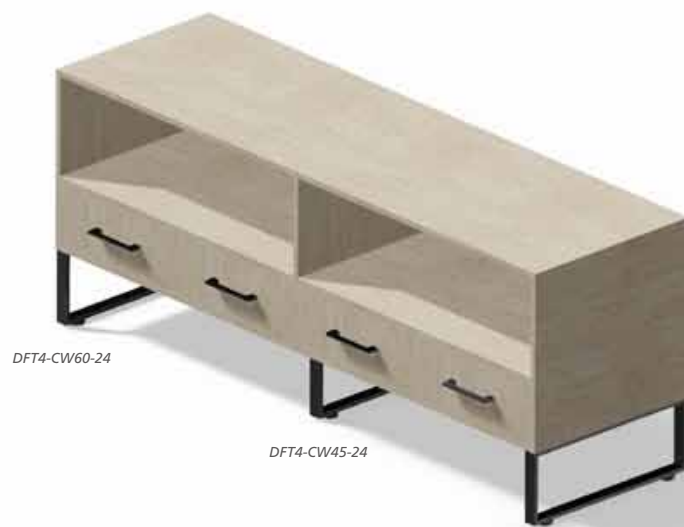

DFT4-CW45-24

DFT4-CW45-24

DFT4-CW60-24

BFT4-CW Cabinet & Sofa Feet

BFT4-CW-17
 Cabinet & Sofa Feet
 *Height: 174mm

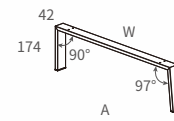
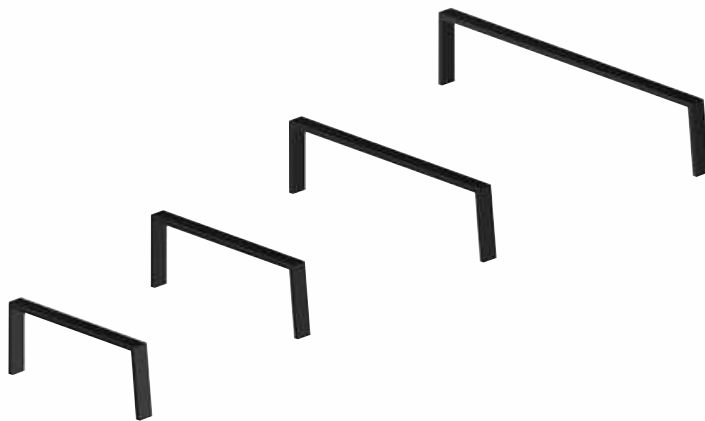
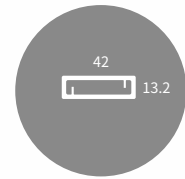
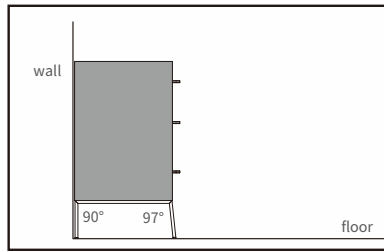

Model No.	W	A
BFT4-CW40-17	396	414
BFT4-CW45-17	446	464
BFT4-CW60-17	596	614
BFT4-CW80-17	796	814



BFT4-CW45-17



BFT4-CW40-17

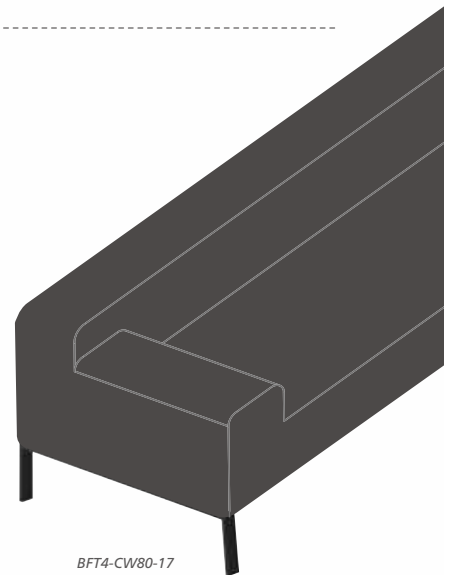

BFT4-CW80-17

ST30 & HST30 Stool Frames

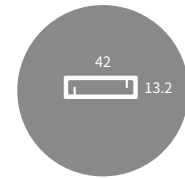
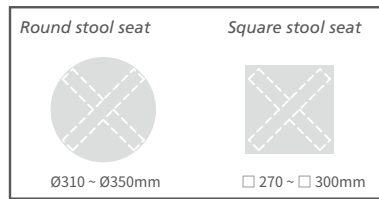

ST30 Stool Frame

*W x W: 296 x 296mm

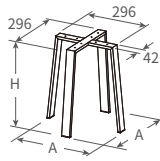

ST30-32

ST30-41

ST30-56

Model No.	A	H
ST30-32	362	320
ST30-41	382	410
ST30-56	412	560

HST30 High Stool Frame

*W x W: 296 x 296mm

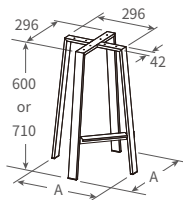

HST30-60



HST30-71

Model No.	A	H
HST30-60	421	600
HST30-71	445	710

ST35 & HST35 Stool Frames

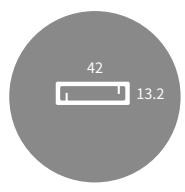
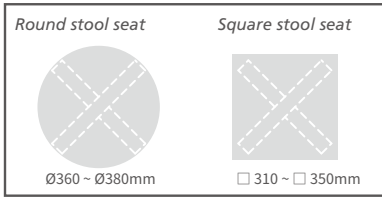

ST35
Stool Frame
 *W x W: 346 x 346mm

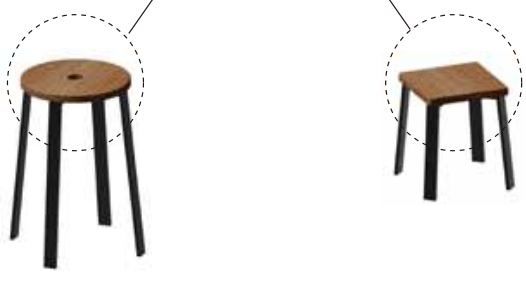
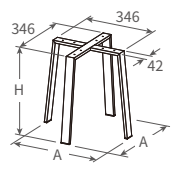

Model No.	A	H
ST35-32	415	320
ST35-41	435	410
ST35-56	465	560



HST35
High Stool Frame
 *W x W: 346 x 346mm

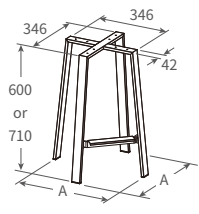

Model No.	A	H
HST35-60	475	600
HST35-71	495	710

ST45 & HST45 Stool Frames

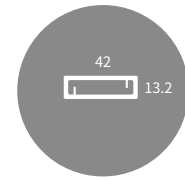
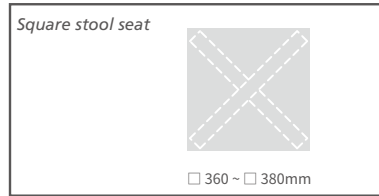

ST45
Stool Frame
*W x W: 446 x 446mm

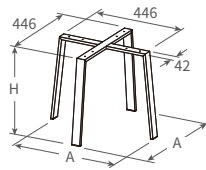

Model No.	A	H
ST45-32	515	320
ST45-41	535	410
ST45-56	565	560



HST45
High Stool Frame
*W x W: 446 x 446mm

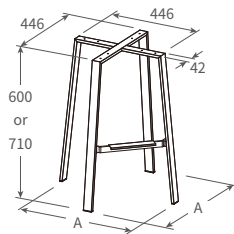

Model No.	A	H
HST45-60	575	600
HST45-71	595	710



CH35 & HCH35 Chair Frames

*Plywood back supporter

**CH35
Chair Frame**

*W x W: 346 x 346mm
*Hight: 410mm

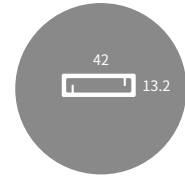
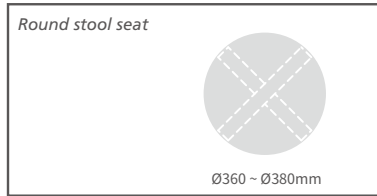
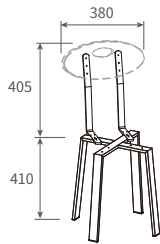

**HCH35
High Chair Frame**

*W x W: 346 x 346mm

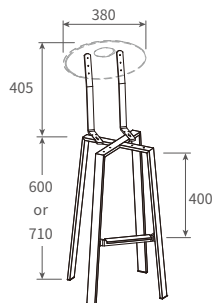

HCH35-60



HCH35-71



Model No.	A	H
HCH35-60	475	600
HCH35-71	495	710

CH45 & HCH45 Chair Frames

*Plywood back supporter

CH45 Chair Frame

*W x W: 446 x 446mm
*Hight: 410mm

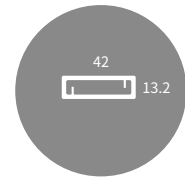
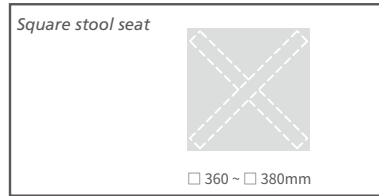
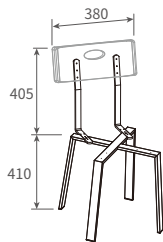

HCH45 High Chair Frame

*W x W: 446 x 446mm

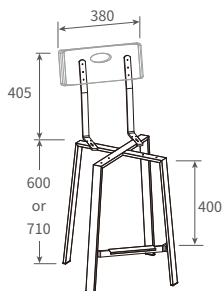

HCH35-60



HCH35-71



Model No.	A	H
HCH45-60	575	600
HCH45-71	595	710

A4 Bench Frames

*W= 296mm

ABH3041
Bench Frame
*Height: 410mm

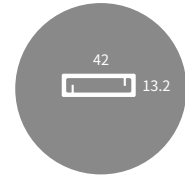
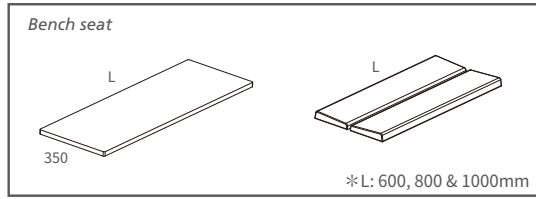

ABH3041-60
L= 588

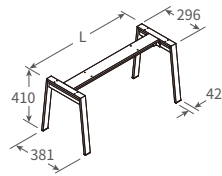

ABH3041-80
L= 788



ABH3041-100
L= 988

ABH3071
High Bench Frame
*Height: 710mm

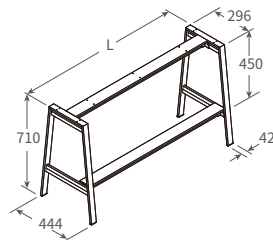

ABH3071-60
L= 588



ABH3071-80
L= 788



ABH3071-100
L= 988

A4 Bench Frames

*W= 346mm

ABH3541
Bench Frame
*Height: 410mm

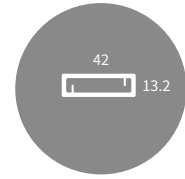
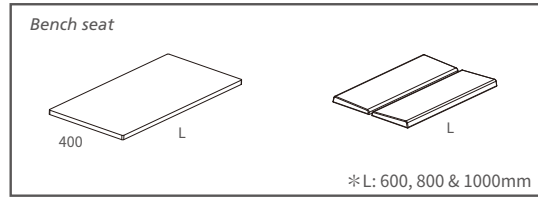

ABH3541-60
L= 588

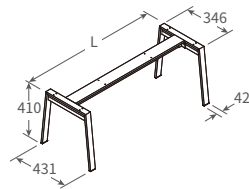

ABH3541-80
L= 788



ABH3541-100
L= 988

ABH3571
High Bench Frame

*Height: 710mm

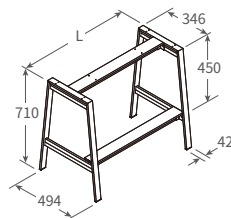

ABH3571-60
L= 588



ABH3571-80
L= 788



ABH3571-100
L= 988

D4 Bench Frames

*W= 396mm

**DBH4041
Bench Frame**

*H: 410mm
*With height adjustable glides (+10mm)

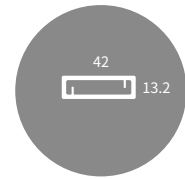
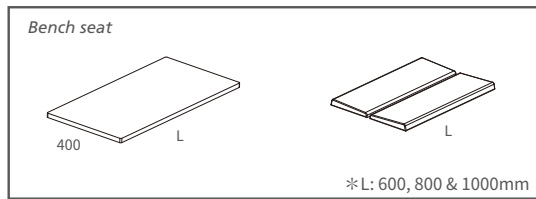

DBH4041-60
L= 588

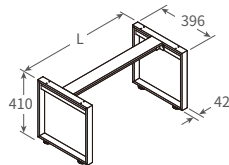

DBH4041-80
L= 788



DBH4041-100
L= 988



**DBH4071
High Stool Frame**

*H: 710mm
*With height adjustable glides (+10mm)

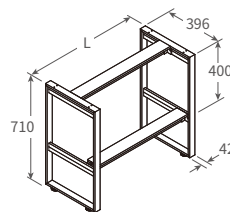

DBH4071-60
L= 588



DBH4071-80
L= 788



DBH4071-100
L= 988



K/D Flat Pack

FLT42 Stool & Chair Frame

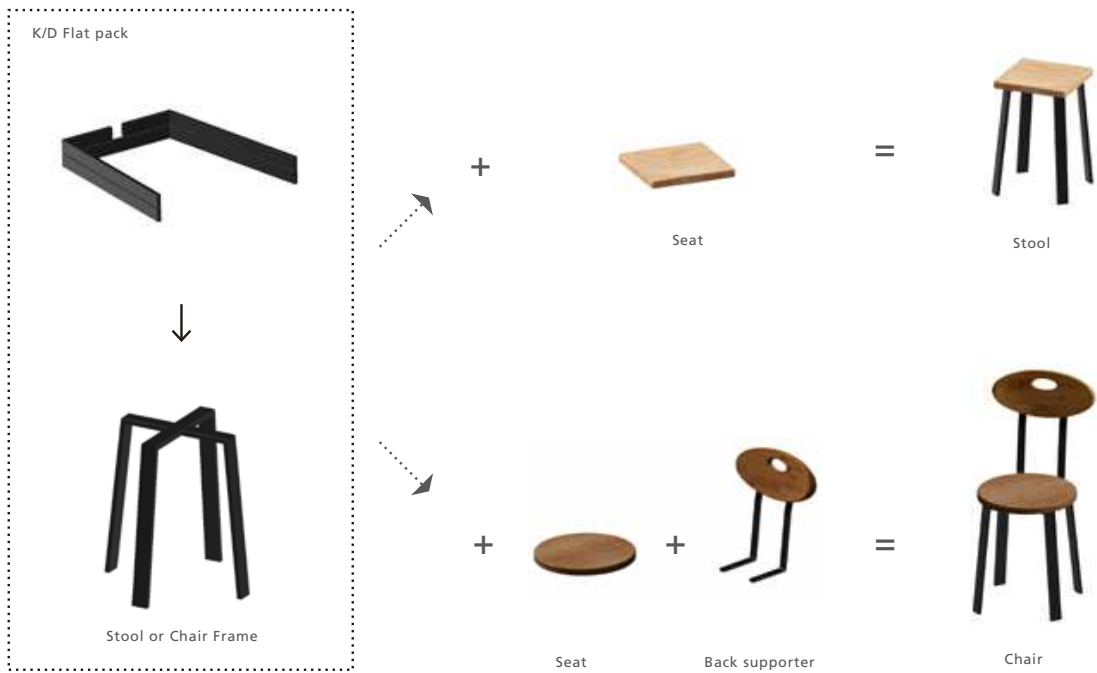

FLT42 Bench Frame + FLT Cross Beam

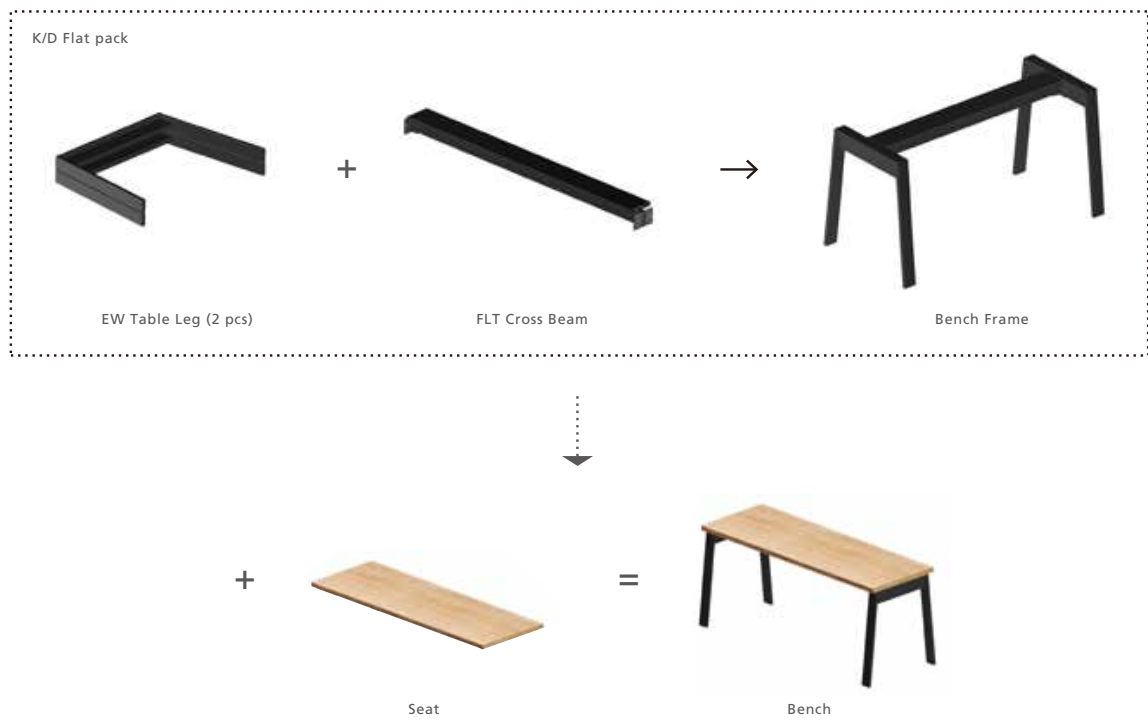

Алматы (7273)495-231
Ангарск (3955)60-70-56
Архангельск (8182)63-90-72
Астрахань (8512)99-46-04
Барнаул (3852)73-04-60
Белгород (4722)40-23-64
Благовещенск (4162)22-76-07
Брянск (4832)59-03-52
Владивосток (423)249-28-31
Владикавказ (8672)28-90-48
Владимир (4922)49-43-18
Волгоград (844)278-03-48
Вологда (8172)26-41-59
Воронеж (473)204-51-73
Екатеринбург (343)384-55-89

Иваново (4932)77-34-06
Ижевск (3412)26-03-58
Иркутск (395)279-98-46
Казань (843)206-01-48
Калининград (4012)72-03-81
Калуга (4842)92-23-67
Кемерово (3842)65-04-62
Киров (8332)68-02-04
Коломна (4966)23-41-49
Кострома (4942)77-07-48
Краснодар (861)203-40-90
Красноярск (391)204-63-61
Курск (4712)77-13-04
Курган (3522)50-90-47
Липецк (4742)52-20-81

Магнитогорск (3519)55-03-13
Москва (495)268-04-70
Мурманск (8152)59-64-93
Набережные Челны (8552)20-53-41
Нижний Новгород (831)429-08-12
Новокузнецк (3843)20-46-81
Ноябрьск (3496)41-32-12
Новосибирск (383)227-86-73
Омск (3812)21-46-40
Орел (4862)44-53-42
Оренбург (3532)37-68-04
Пенза (8412)22-31-16
Петрозаводск (8142)55-98-37
Псков (8112)59-10-37

Пермь (342)205-81-47
Ростов-на-Дону (863)308-18-15
Рязань (4912)46-61-64
Самара (846)206-03-16
Саранск (8342)22-96-24
Санкт-Петербург (812)309-46-40
Саратов (845)249-38-78
Севастополь (8692)22-31-93
Симферополь (3652)67-13-56
Смоленск (4812)29-41-54
Сочи (862)225-72-31
Ставрополь (8652)20-65-13
Сургут (3462)77-98-35
Сыктывкар (8212)25-95-17
Тамбов (4752)50-40-97

Тверь (4822)63-31-35
Тольятти (8482)63-91-07
Томск (3822)98-41-53
Тула (4872)33-79-87
Тюмень (3452)66-21-18
Ульяновск (8422)24-23-59
Улан-Удэ (3012)59-97-51
Уфа (347)229-48-12
Хабаровск (4212)92-98-04
Чебоксары (8352)28-53-07
Челябинск (351)202-03-61
Череповец (8202)49-02-64
Чита (3022)38-34-83
Якутск (4112)23-90-97
Ярославль (4852)69-52-93

Россия +7(495)268-04-70

Казахстан +7(7172)727-132

Киргизия +996(312)96-26-47

www.fourwinds.nt-rt.ru | | fse@nt-rt.ru