

Алматы (7273)495-231	Иваново (4932)77-34-06	Магнитогорск (3519)55-03-13	Пермь (342)205-81-47	Тверь (4822)63-31-35
Ангарск (3955)60-70-56	Ижевск (3412)26-03-58	Москва (495)268-04-70	Ростов-на-Дону (863)308-18-15	Тольятти (8482)63-91-07
Архангельск (8182)63-90-72	Иркутск (395)279-98-46	Мурманск (8152)59-64-93	Рязань (4912)46-61-64	Томск (3822)98-41-53
Астрахань (8512)99-46-04	Казань (843)206-01-48	Набережные Челны (8552)20-53-41	Самара (846)206-03-16	Тула (4872)33-79-87
Барнаул (3852)73-04-60	Калининград (4012)72-03-81	Нижний Новгород (831)429-08-12	Саранск (8342)22-96-24	Тюмень (3452)66-21-18
Белгород (4722)40-23-64	Калуга (4842)92-23-67	Новокузнецк (3843)20-46-81	Санкт-Петербург (812)309-46-40	Ульяновск (8422)24-23-59
Благовещенск (4162)22-76-07	Кемерово (3842)65-04-62	Ноябрьск (3496)41-32-12	Саратов (845)249-38-78	Улан-Удэ (3012)59-97-51
Брянск (4832)59-03-52	Киров (8332)68-02-04	Новосибирск (383)227-86-73	Севастополь (8692)22-31-93	Уфа (347)229-48-12
Владивосток (423)249-28-31	Коломна (4966)23-41-49	Омск (3812)21-46-40	Симферополь (3652)67-13-56	Хабаровск (4212)92-98-04
Владикавказ (8672)28-90-48	Кострома (4942)77-07-48	Орел (4862)44-53-42	Смоленск (4812)29-41-54	Чебоксары (8352)28-53-07
Владимир (4922)49-43-18	Краснодар (861)203-40-90	Оренбург (3532)37-68-04	Сочи (862)225-72-31	Челябинск (351)202-03-61
Волгоград (844)278-03-48	Красноярск (391)204-63-61	Пенза (8412)22-31-16	Ставрополь (8652)20-65-13	Череповец (8202)49-02-64
Вологда (8172)26-41-59	Курск (4712)77-13-04	Петрозаводск (8142)55-98-37	Сургут (3462)77-98-35	Чита (3022)38-34-83
Воронеж (473)204-51-73	Курган (3522)50-90-47	Псков (8112)59-10-37	Сыктывкар (8212)25-95-17	Якутск (4112)23-90-97
Екатеринбург (343)384-55-89	Липецк (4742)52-20-81		Тамбов (4752)50-40-97	Ярославль (4852)69-52-93

Россия +7(495)268-04-70

Казахстан +7(7172)727-132

Киргизия +996(312)96-26-47

www.fourwinds.nt-rt.ru | fse@nt-rt.ru

Технические характеристики на фитинги, соединители, петли и держатели для полок компании **Four Winds**

Виды товаров: петли для стеклянных дверей, соединители витринных стекол, зажимы для стеклянных створок, настенные держатели для полок, опоры для стеклянных полок и фитинги, скрытые полкодержатели, штифты-полкодержатели и др.

07-1 Glass Door Hinges

21825 Cabinet Glass Door Hinge

- * Material: zinc alloy
- * Finish: polished or satin chrome plated, silver gray or black coated
- * For inset door
- * For glass of 4 ~ 6mm thickness

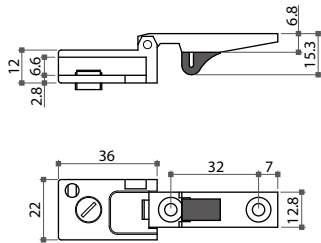

Item No.	Glass thickness
21825	4 ~ 6mm

21870 Cabinet Glass Door Hinge

- * Material: zinc alloy
- * Finish: black, brass or chrome plated
- * For glass of 5mm thickness maximum

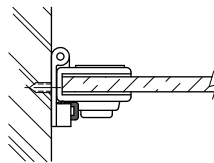
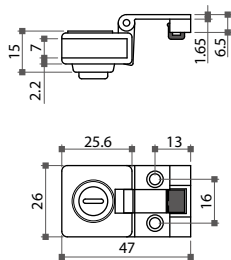

Item No.	Glass thickness
21870	max. 5mm

21870H Cabinet Glass Door Hinge

- * Material: zinc alloy
- * Finish: black, brass or chrome plated
- * For glass of 5mm thickness maximum

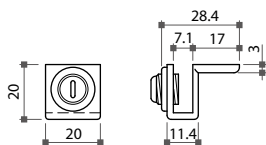

Item No.	Glass thickness
21870H	max. 5mm

07-1 Glass Door Hinges

Glass Door Hinge

- * Material: zinc alloy
- * Facial patterns: framed (21830) or mirror (21831)
- * Finish: various metallic finishes are available
- * 170° opening and self-closing
- * For inset door
- * Top and bottom mount, for glass of 5 ~ 6mm thickness

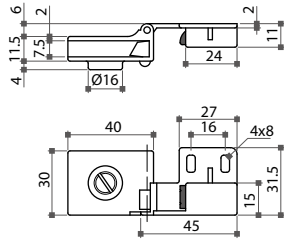

Item No.	Feature
21830	boundary part
21831	boundary part



21835 Central Glass Door Hinge

- * Material: zinc alloy, framed face only
- * Finish: various metallic finishes are available
- * 170° opening and self-closing
- * For inset door
- * Central mount, for glass of 5 ~ 6mm thickness

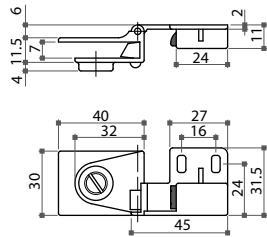

Item No.	Feature
21835	central part



21833 Glass Door Handle

- * Material: zinc alloy, framed face only
- * Finish: various metallic finishes are available
- * Central mount, for glass of 5 ~ 6mm thickness

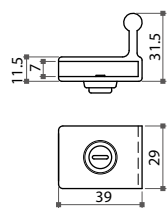

Item No.	Feature
21833	door handle



21840 Cabinet Glass Door Hinge

- * Material: zinc alloy, framed face only
- * 170° opening
- * For overlay door with self-closing catch
- * Top and bottom mount, for glass of 5 ~ 6mm thickness

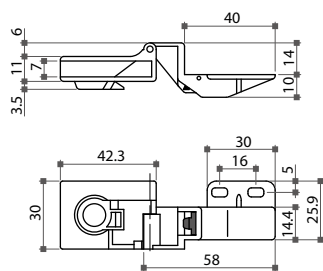

Item No.	Glass thickness
21840	5 ~ 6mm

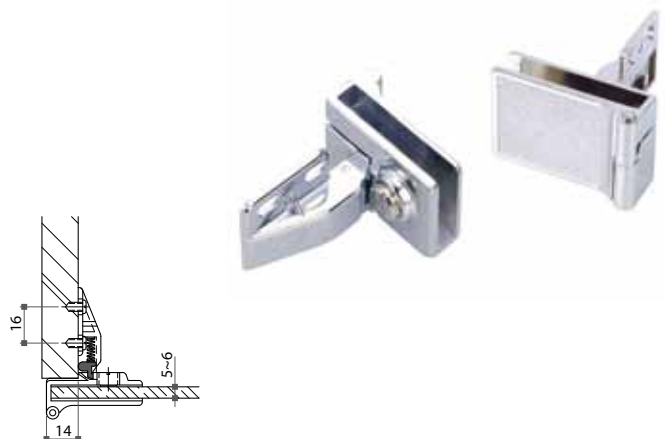

07-1 Glass Door Hinges

28410 Cabinet Glass Door Hinge

- * Material: brass
- * Finish: polished chrome
- * For glass of 6 ~ 8mm thickness
- * Loading capacity: 12 kgs

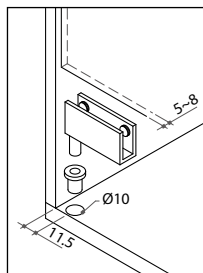
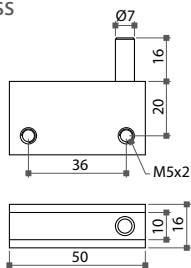
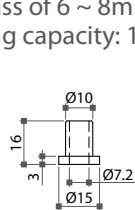

Item No.	Glass thickness
28410	6 ~ 8mm

68410 Swing Glass Pivot Lock

- * Material: brass
- * Finish: polished chrome
- * For 8mm glass thickness
- * Accessories: 2 pcs cut washers, 2 pcs square washers and 1 pc 30mm straight cam
- * Available in K/A (key alike), K/D (key different) and master key system

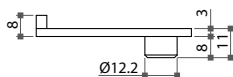
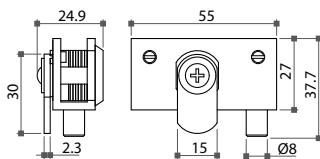
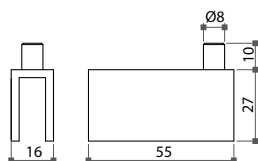

Item No.	Glass thickness
68410	8mm

Non-Boring Glass Door Hinge

- * Material: zinc alloy
- * Finish: polished chrome
- * For glass of 5mm, 6mm or 8mm thickness
- * Accessories: 2 screws, 1 L-type plastic and 1 plastic block per piece
- * 2 hinges (top and bottom) per set

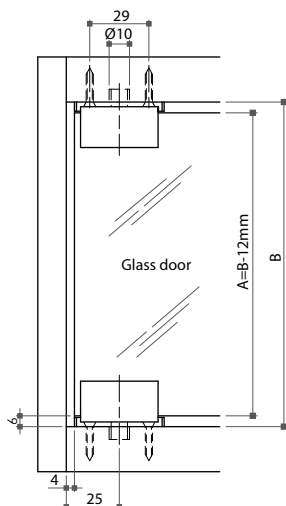
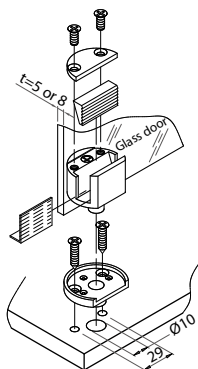

Item No.	Glass thickness
21855	5mm
21856	6mm
21858	8mm

07-1 Glass Door Hinges

21697 Cabinet Glass Door Hinge

- * Material: steel
- * Size: 40x14.5mm
- * For glass of 4 ~ 6mm thickness
- * Finish: black, brass, chrome or silver gray
- * Accessories: 2 hinges, 2 plastic bushings, 2 self-adhesive plates (or 2 nylon U-plates) and 4 M4x6mm metal screws

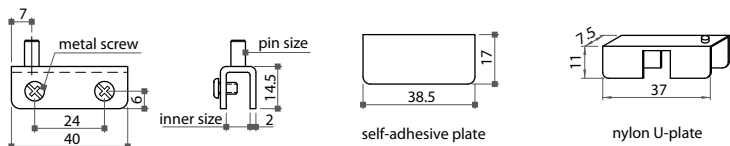

Item No.	Inner size	Glass thickness
21697	7.8mm	4 ~ 6mm



21805 Cabinet Glass Door Hinge

- * Material: steel
- * Size: 50x23mm
- * Pin size: Ø5x9mm
- * Inner size: 8mm
- * For glass of 4 ~ 6mm thickness
- * Finish: black, brass or chrome
- * Accessories: 2 hinges, 2 plastic bushings and 4 M8 plastic screws

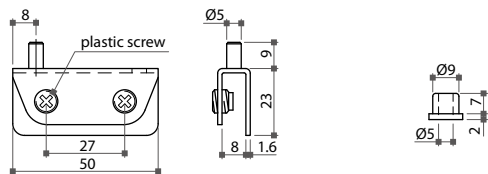

Item No.	Inner size	Glass thickness
21805	8mm	4 ~ 6mm



21770 Cabinet Glass Door Hinge

- * Material: steel
- * Size: 40x20mm
- * Inner size: 7.0mm
- * For glass of 3 ~ 5mm thickness
- * For overlay door
- * Finish: black, brass or chrome
- * Accessories: 2 hinges and 2 M10 plastic screws

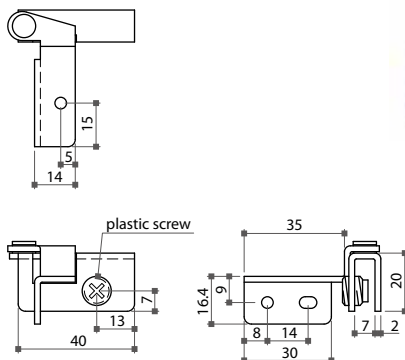

Item No.	Inner size	Glass thickness
21770	7.0mm	3 ~ 5mm



07-1 Glass Door Hinges

21670 Cabinet Glass Door Hinge

- * Material: steel
- * Size: 40x13.5mm
- * Inner size: 7.8mm
- * For glass of 4 ~ 6mm thickness
- * Pin size: Ø5x9mm
- * Finish: black, brass, chrome or silver gray
- * Accessories: 2 hinges, 2 plastic bushings and 4 M8 plastic screws

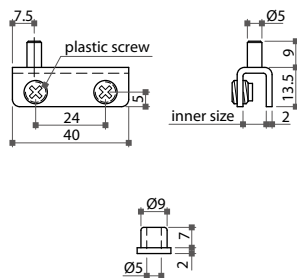

Item No.	Inner size	Glass thickness
21670	7.8mm	4 ~ 6mm

21755 Cabinet Glass Door Hinge

- * Material: steel
- * Size: 40x20mm
- * Inner size: 7.5mm
- * For glass of 4 ~ 6mm thickness
- * For inlay door
- * Finish: black, brass or chrome
- * Accessories: 2 hinges, 2 self-adhesive plates, 4 M4x6mm metal screws

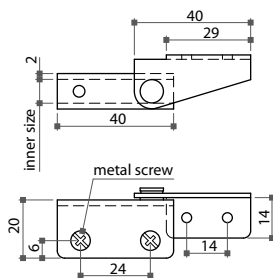

Item No.	Inner size	Glass thickness
21755	5.6mm	4 ~ 6mm

self-adhesive plate

21890 Cabinet Glass Door Hinge

- * Material: steel
- * Size: 40x20mm
- * Pin size: Ø5x9mm
- * Inner size: 8.2mm
- * For glass of 5 ~ 6mm thickness
- * Finish: black, brass or chrome
- * Accessories: 2 hinges, 2 plastic bushings and 4 M8 plastic screws

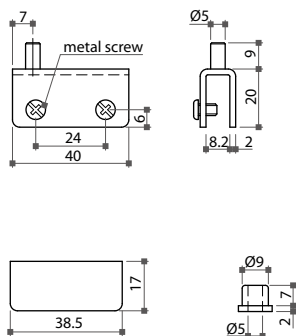

Item No.	Inner size	Glass thickness
21890	8.2mm	5 ~ 6mm

self-adhesive plate

21752 Cabinet Glass Door Hinge

- * Material: steel
- * Size: 40x20mm
- * For glass of 5 ~ 6mm thickness
- * For inlay door
- * Finish: black, brass or chrome
- * Accessories: 2 pcs of hinges and 4 M8 plastic screws

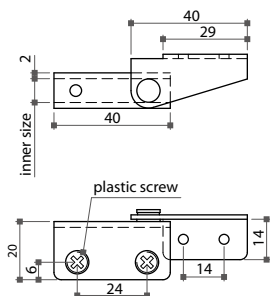

Item No.	Inner size	Glass thickness
21752	8.2mm	5 ~ 6mm

07-1 Glass Door Hinges

21884 Cabinet Glass Door Hinge, Round Face

- * Material: solid brass / zinc alloy
- * For 5 ~ 6mm thick inset glass door with $\varnothing 19\text{mm}$ borehole
- * 3 kgs load with catch in closed position
- * $\varnothing 25\text{mm}$ round face in polished chrome, satin chrome or polished brass

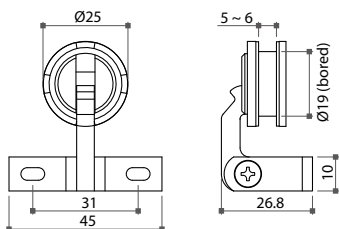

Item No.	Glass thickness
21884	5 ~ 6mm

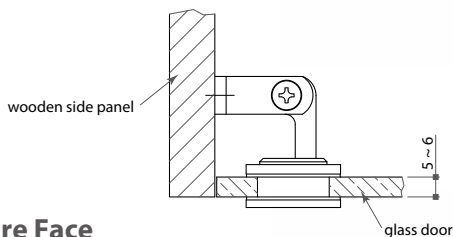

21886 Cabinet Glass Door Hinge, Square Face

- * Material: solid brass / zinc alloy
- * For 5 ~ 6mm thick inset glass door with $\varnothing 19\text{mm}$ borehole
- * 3 kgs load with catch in closed position
- * Square face 25x25mm in polished chrome, satin chrome or polished brass

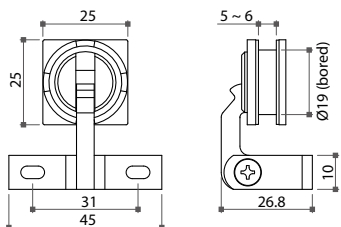

Item No.	Glass thickness
21886	5 ~ 6mm

21880 Cabinet Glass Door Hinge

- * Material: steel hinge with brass button
- * Finish: black, brass or chrome plated
- * For max. 5mm thick glass and $\varnothing 6\text{mm}$ borehole

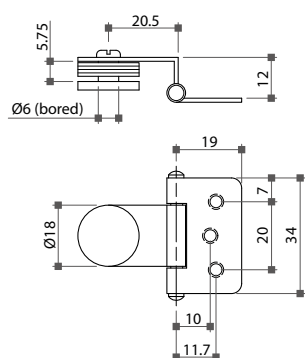

Item No.	Glass thickness
21880	max. 5mm



07-1 Glass Door Hinges

Glass Door Hinge

- * Ø26mm cup
- * Material: black nylon cup with nickel plated steel mounting plate
- * Spring loaded self-closing
- * For glass of 4 ~ 6mm thickness
- * Available with various mounting plates: for chipboard screws (2 or 4 screws), premounted with wood screws or Euro screws, premounted with Ø5mm nylon expanding dowels
- * 30°, 45° and 90° corner hinges are also available

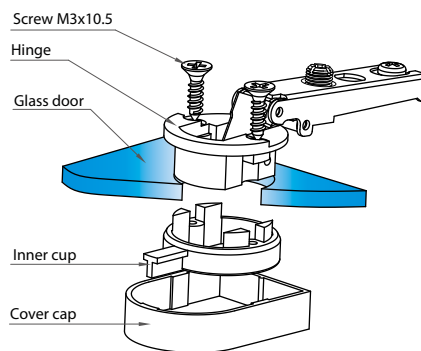

D	F	H	0	2	4
5	17	15	13		
6	18	16	14		
7	19	17	15		

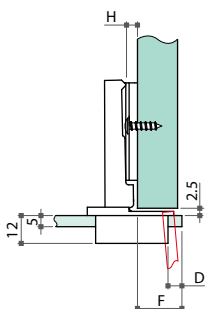

Item No.	Type
U2761	full overlay



D	F	H	0	2	4
5	10	8	6		
6	11	9	7		
7	12	10	8		

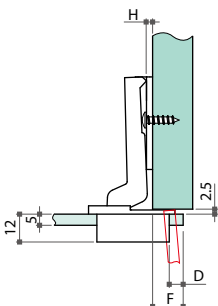

Item No.	Type
U2763	half overlay



D	L	H	0	2	4
5	-2	0	2		
6	-3	-1	1		
7	-4	-2	0		

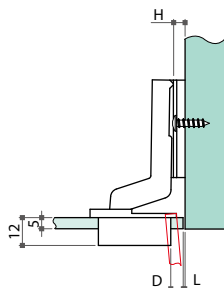

Item No.	Type
U2765	inset



Cover Cap

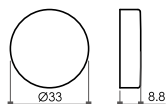

Color	Item No.
Black	#RCP-BK
Gold	#RCP-GD
Chrome	#RCP-PC
Matt chrome	#RCP-SC

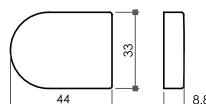

Color	Item No.
Black	#DCP-BK
Gold	#DCP-GD
Chrome	#DCP-PC
Matt chrome	#DCP-SC

07-2 Showcase Connectors

931 Series Glass Shelf Connector

- * Material: solid brass
- * Finish: BNI (brushed nickel), BSN (brushed satin nickel), GP (gold plated) or PC (polished chrome)
- * For glass of 10mm thickness

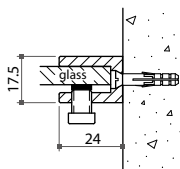

Item No.	Size (LxH)	Glass thickness
93130	24x17.5mm	10mm

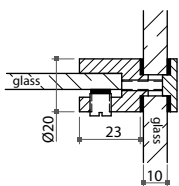
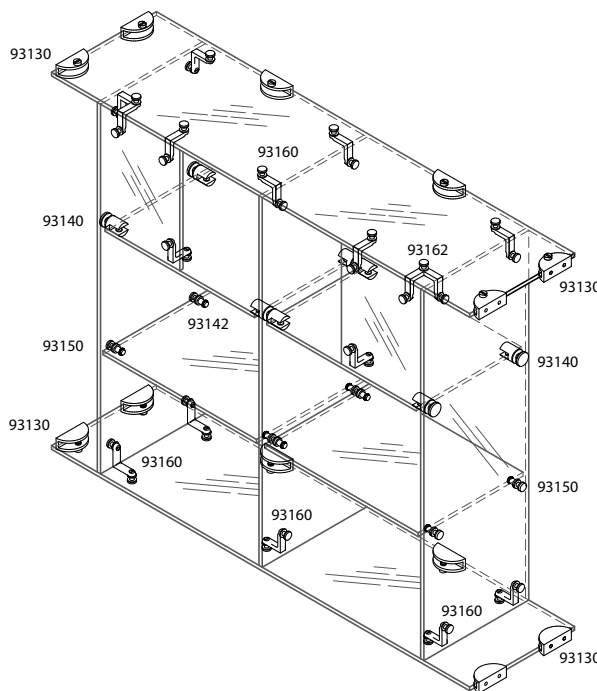

Item No.	Size	Glass thickness
93140	23xØ20mm	10mm

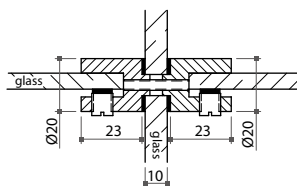

Item No.	Size	Glass thickness
93142	23xØ20mm	10mm

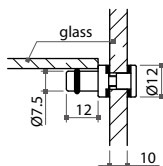

Item No.	Size	Glass thickness
93150	12xØ7.5mm	10mm

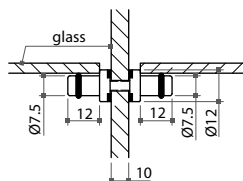

Item No.	Size	Glass thickness
93152	12xØ7.5mm	10mm

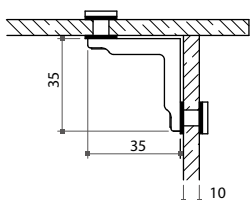

Item No.	Size	Glass thickness
93160	35x35mm	10mm

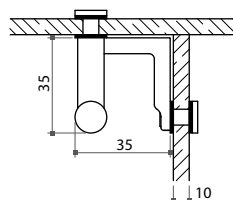

Item No.	Size	Glass thickness
93162	35x35mm	10mm

07-2 Showcase Connectors

93210 Glass Shelf Support

- * Material: solid aluminium
- * For glass of 3 ~ 10mm thickness
- * Finish: nature or brass anodized

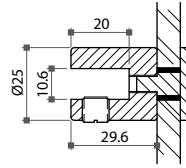

Item No.	Glass thickness
93210	3 ~ 10mm

90351 Shelf & Signage Holder

- * Material: stainless steel or aluminium
- * Various options in colors / finishes or sizes
- * For glass of 5 ~ 10mm thickness

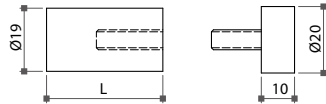

Item No.	L
90351-18	18mm
90351-35	35mm
90351-40	40mm
90351-50	50mm
90351-60	60mm



90360 Stand-Off Sign Holder

- * Material: solid brass, steel or stainless steel
- * Mounted without borehole
- * For glass of 5 ~ 8mm thickness
- * Length: 30, 38 & 50mm
- * Accessories: 2 plastic washers

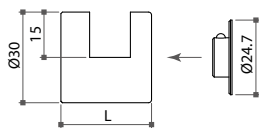

Item No.	L
90360-30	30mm
90360-38	38mm
90360-50	50mm

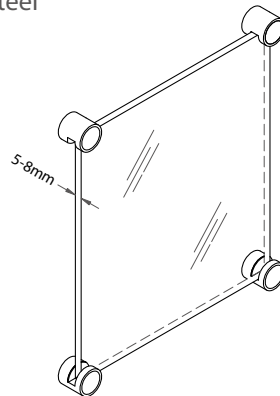

90370 Stand-Off Sign Holder

- * Material: solid brass, steel, stainless steel or aluminium
- * For glass of 5 ~ 8mm thickness
- * Length (L): 30, 38 & 50mm (other sizes can be specified)
- * Accessories: 1 threaded pin, 2 plastic washers

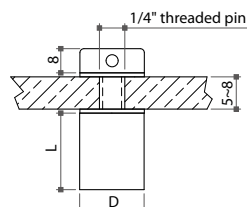

Item No.	D
90370-16	Ø16mm
90370-19	Ø19mm
90370-30	Ø30mm



07-2 Showcase Connectors

93360 Glass Clamp

- * Material: stainless steel or aluminium
- * Various options in colors/finishes
- * For glass of 5 ~ 10mm thickness

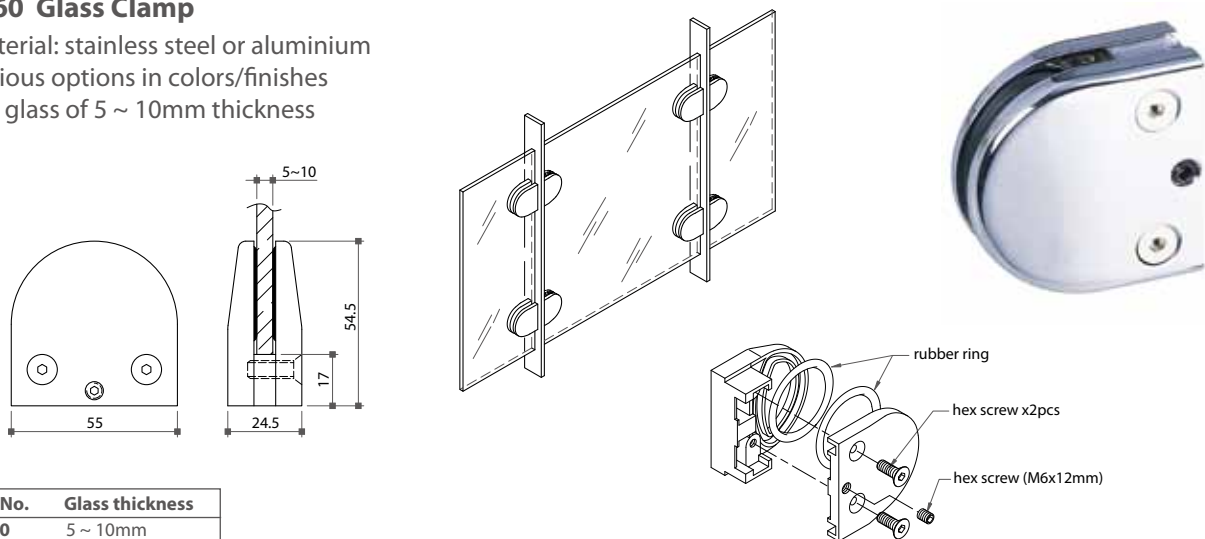

Item No.	Glass thickness
93360	5 ~ 10mm

93365 Glass Clamp

- * Material: zinc alloy or aluminium
- * Finish: chrome, matt nickel, gold or black plated
- * For glass of 5 ~ 10mm thickness
- * Accessories: 2 rubber rings, 1 hex screw (M6x12mm)

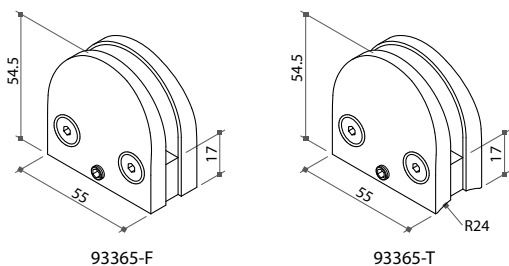

93365-F

93365-T



93365-F

93365-T

Item No.	Application
93365-F	for flat surface
93365-T	for tube (Ø2")

93369 Glass Clamp

- * Material: stainless steel
- * Finish: plain or polished
- * For glass of 6 ~ 8mm thickness
- * Accessories: rubber pads (2mmx4 pcs & 1mmx2 pcs)

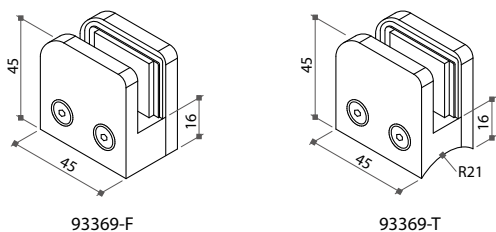

93369-F

93369-T



93369-F

93369-T

Item No.	Application
93369-F	for flat surface
93369-T	for tube (Ø1-1/2")

07-2 Showcase Connectors

Aluminium Extrusion Glass Connector

- * Material: aluminium extrusion
- * For glass of 5, 10, 12, 16 or 19mm thickness
- * Finish: natural anodize, brass or chrome plated with polished surface, high quality

93700 2-way 180°



93000 2-way 90°



93100 3-way 90°



93800 3-way 120°



93200 4-way 90°



93900 2-way free swing



Zinc Alloy Glass Connector

- * Material: zinc alloy
- * For glass of 5mm thickness
- * Finish: bright chrome, brass plated or black

93300 2-way 90°



93305 2-way 120°



93400 3-way 90°



93600 3-way 120°



93405 3-way cross 90°



93500 4-way 90°



93505 4-way cross 90°



93315 2-way free swing



07-3 Glass Shelf Supports & Fittings

9395 Glass Shelf Holder

- * Material: solid brass (SB), stainless steel (SS) or aluminium (AL)
- * Various metallic finishes are available

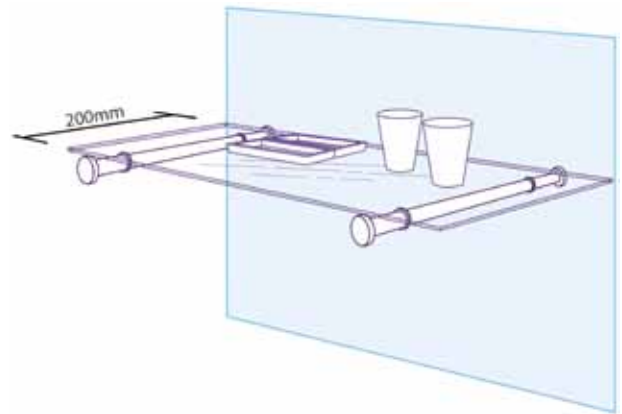

93950

- * Wall mounting with nylon plug $\text{Ø}10 \times 60\text{mm}$ L.
- * Height adjustable for 6mm after mounting

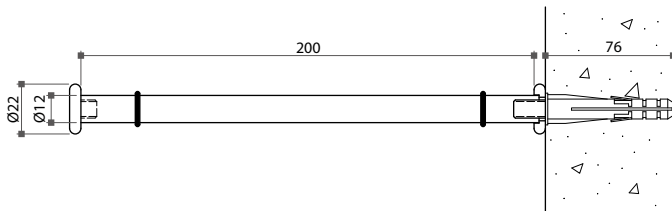

93951

- * Panel attachment with M8 insert nut

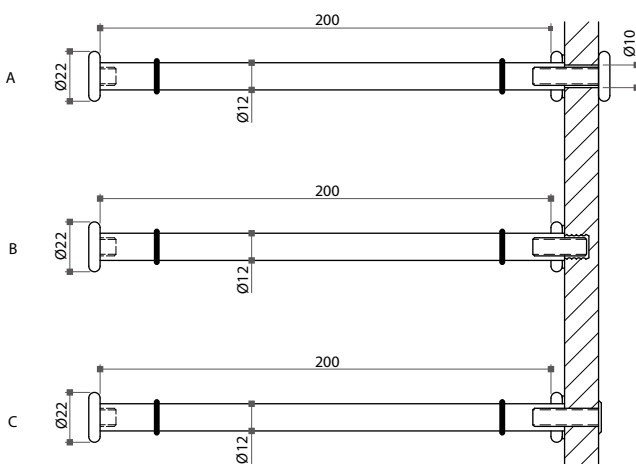

07-3 Glass Shelf Supports & Fittings

Wall Shelf Gripper - Oval type

- * For shelves and table tops of any material (wood, glass, ...) of 4 ~ 40mm thickness
- * Material: zinc alloy
- * Finish: satin chrome, satin nickel, polished chrome, gold plated or silver coated
- * 2 pcs/pair

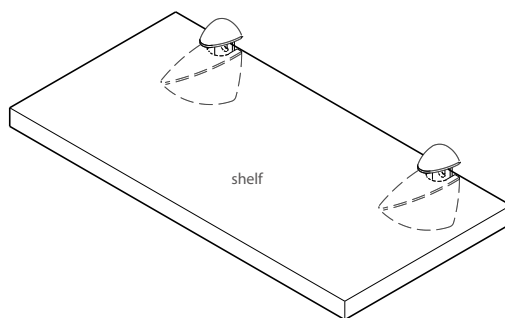
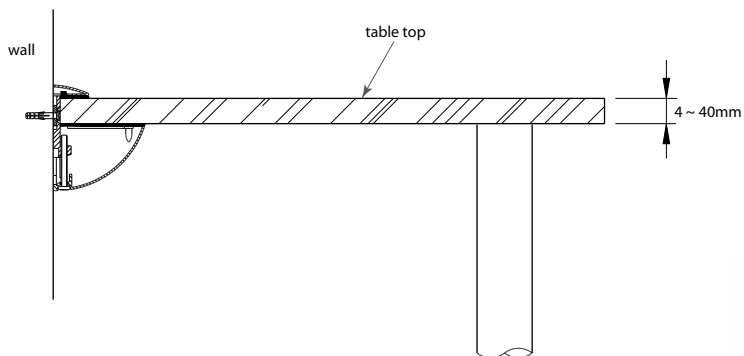

07 Shelf & Glass Fittings



93930



93931



93932

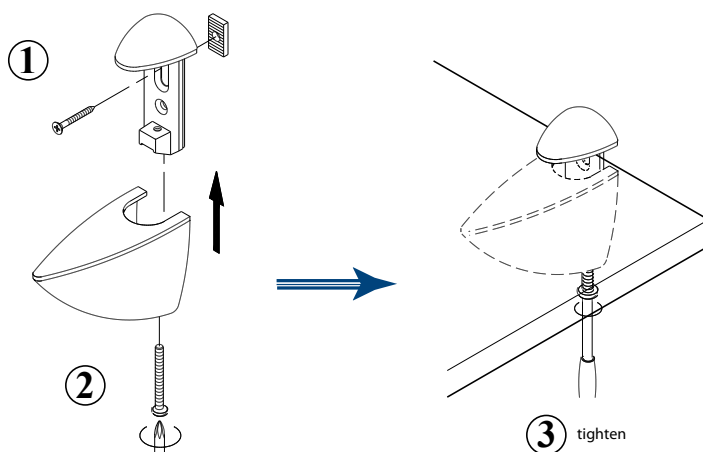
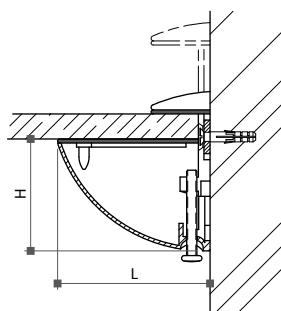

Item No.	Dimension (LxH)	Shelf thickness
93930	56x45mm	4 ~ 16mm
93931	76x55mm	4 ~ 26mm
93932	107x71mm	4 ~ 40mm

07-3 Glass Shelf Supports & Fittings

Wall Shelf Gripper - Square type

- * For shelves and table tops of any material (wood, glass, ...) of 4 ~ 30mm thickness
- * Material: zamak
- * Finish: satin chrome, satin nickel plated or silver coated
- * 2 pcs/pair

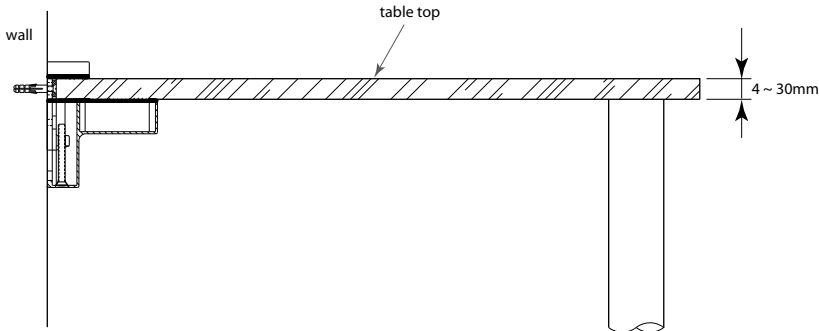
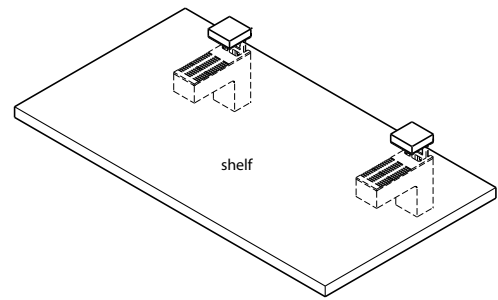

93980



93981

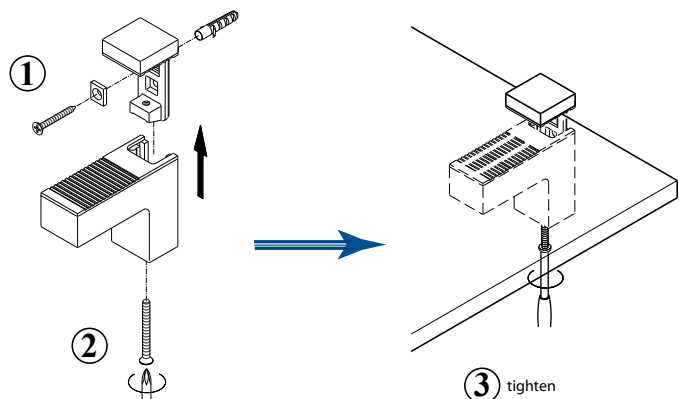
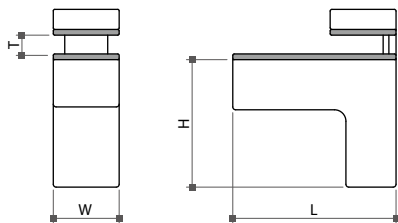

Item No.	Dimension (LxHxW)	Shelf thickness (T)
93980	57x44.5x24mm	4 ~ 18mm
93981	80x62x31mm	4 ~ 30mm

07-3 Glass Shelf Supports & Fittings

Wall Shelf Grippers - Flat type

- * For shelves or table tops (wood & glass) of 5 ~ 50mm thickness
- * Material: zinc alloy
- * Finish: polished chrome or brushed nickel (stainless steel look)
- * With or without high power LED light (1W/350mA), 20° tilt and swivel type

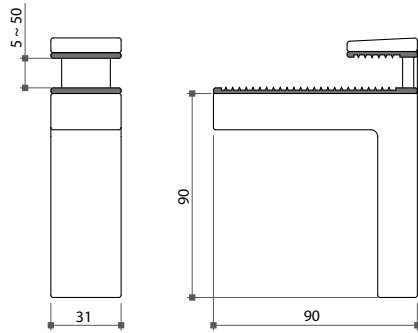

93986

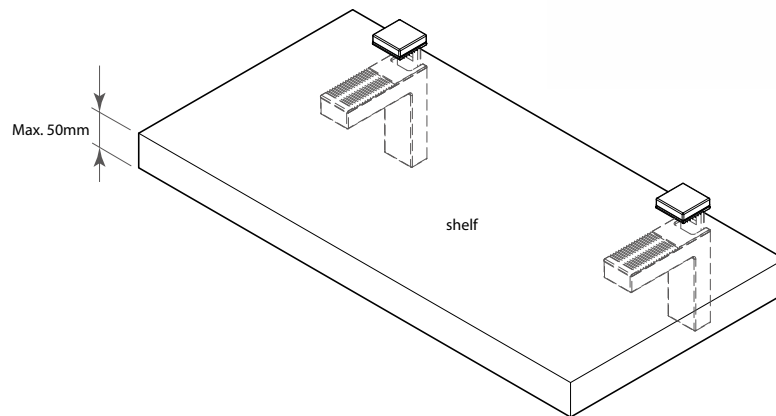

93986-LED

- * With LED spot light (swivel)

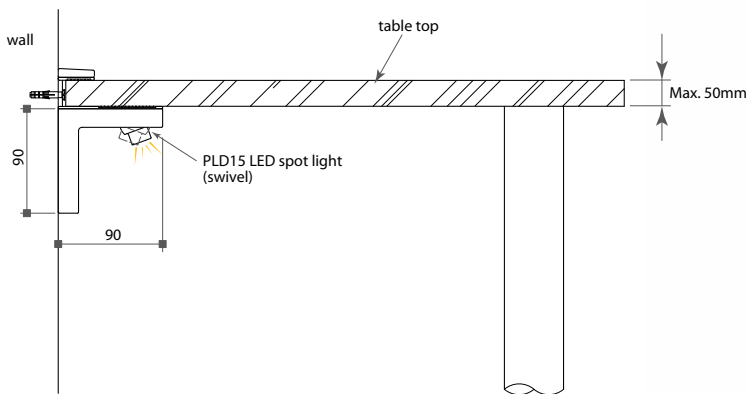

93986-LED

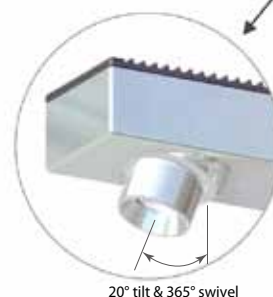

20° tilt & 365° swivel

Item No.	Type	Dimension	Shelf thickness
93986	without LED light	90x90x31mm	5 ~ 50mm
93986-LED	with LED light		

07-3 Glass Shelf Supports & Fittings

93953 Long Glass Shelf Gripper

- * For glass of 4 ~ 8mm thickness
- * Material: zinc alloy
- * Finish: polished chrome or brushed nickel (stainless steel look)
- * With or without high power LED spot light (1W/350mA), 20° tilt and swivel type

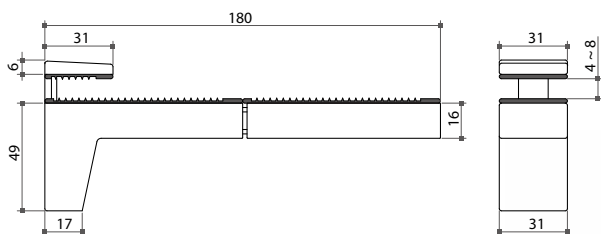

93953

93953-LED

- * With LED spot light (swivel)

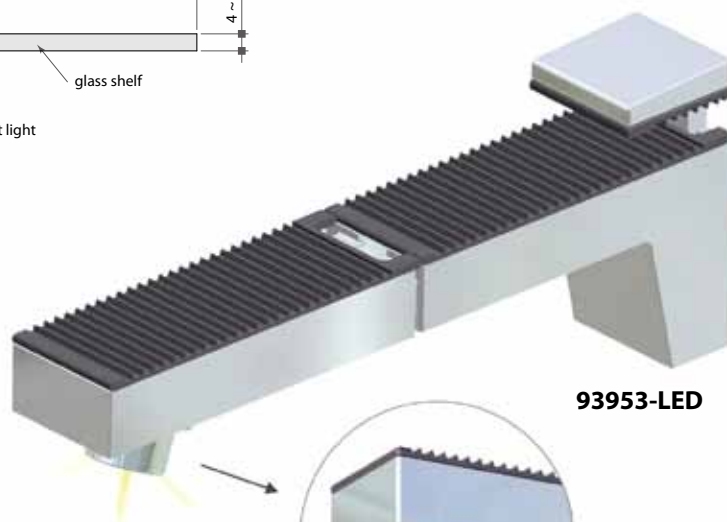
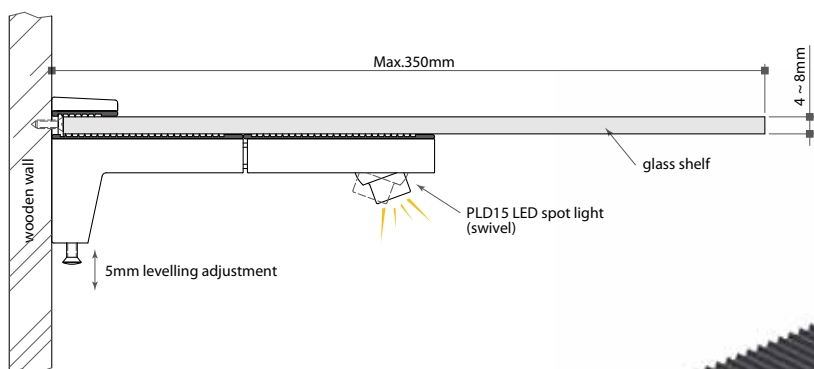

93953-LED

(Light class for reading)



20° tilt & 360° swivel

Item No.	Type	Dimension	Shelf thickness
93953	without LED light	180x49x31mm	4 ~ 8mm
93953-LED	with LED light		

07-3 Glass Shelf Supports & Fittings

93955 Long Wooden Shelf Gripper

- * Wood screws mount under the wooden panels of any thickness
- * With +5mm levelling adjustment
- * Material: zinc alloy
- * Finish: polished chrome or brushed nickel (stainless steel look)
- * With or without high power LED spot light (1W/350mA), 20° tilt and swivel type

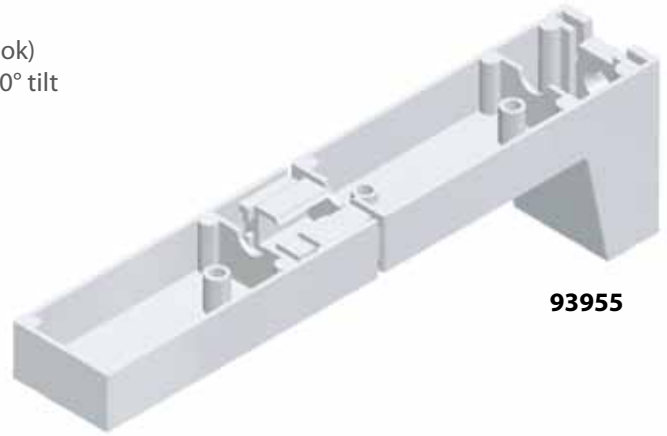
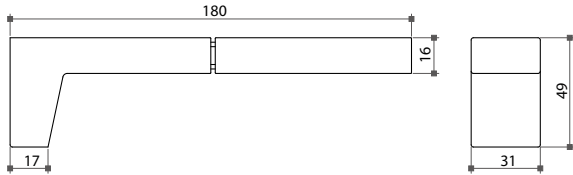

93955

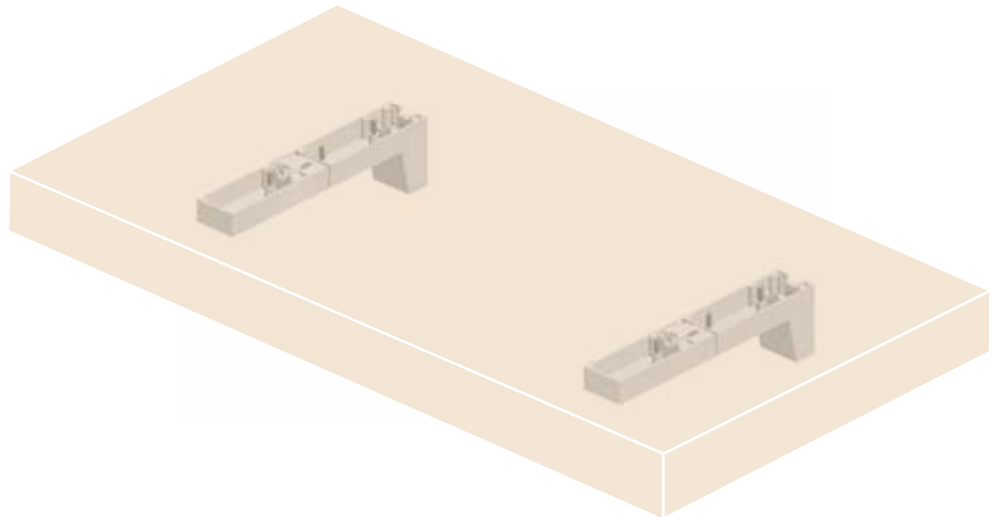

93955-LED

- * With LED spot light (swivel)

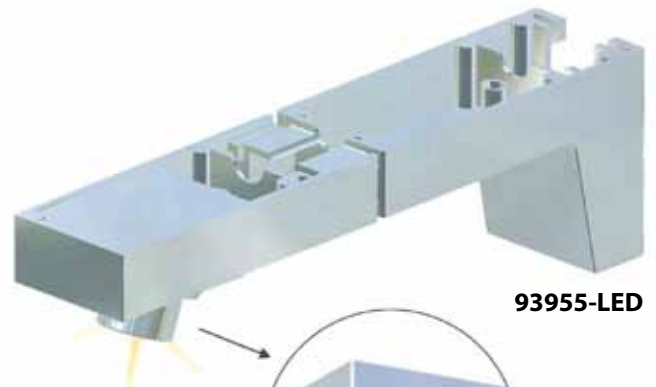
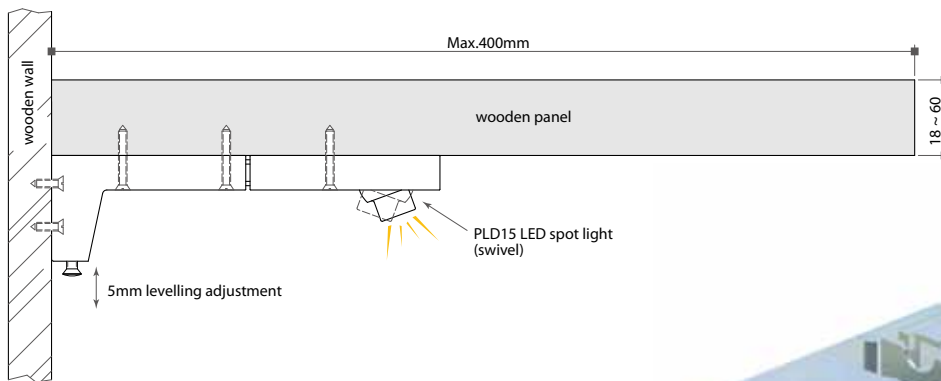

93955-LED

(Light class for reading)

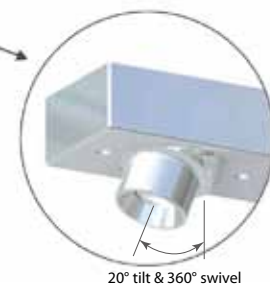

20° tilt & 360° swivel

Item No.	Type	Dimension	Shelf thickness
93955	without LED light	180x49x31mm	18 ~ 60mm
93955-LED	with LED light	180x49x31mm	18 ~ 60mm

07-3 Glass Shelf Supports & Fittings

65842 Shelf Holder

- * Screw fixing on the wooden shelf or UV gluing on the tempered glass with Ø15mm aluminium parts (not included)
- * Material: zinc alloy
- * Size: 187x176x16mm
- * Finish: silver gray coated or polished chrome plated

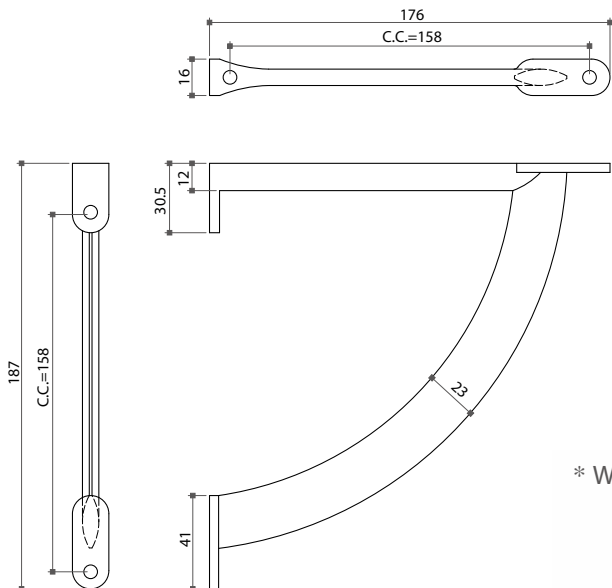

* Wooden shelf - screw fixing



* Glass shelf - UV gluing

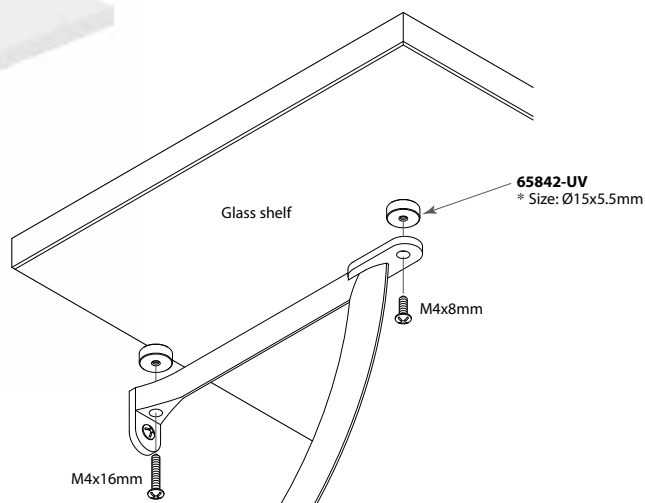

07-3 Glass Shelf Supports & Fittings

Concealed Shelf Holder

58485 Machining for 115mm

58486 Machining for 155mm

* For shelves of 50mm thickness minimum (honeycomb board) and 300mm depth

* Adjustments: vertical ± 4 mm, horizontal ± 4 mm, inclination $-2^\circ + 4^\circ$

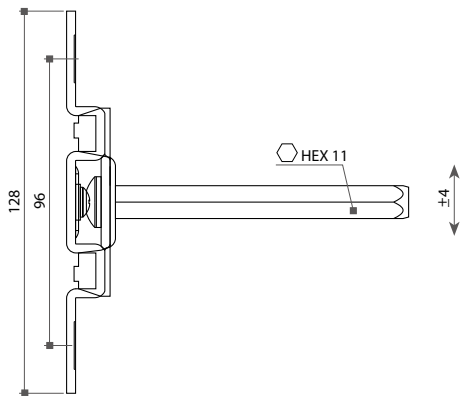
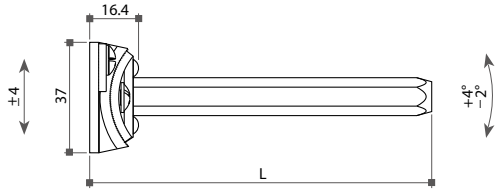

Item No.	L
58485	115mm
58486	155mm

58485 Machining for 115mm

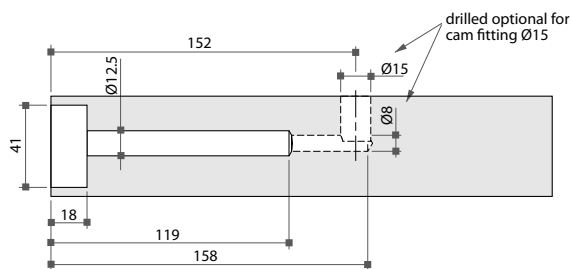

58486 Machining for 155mm

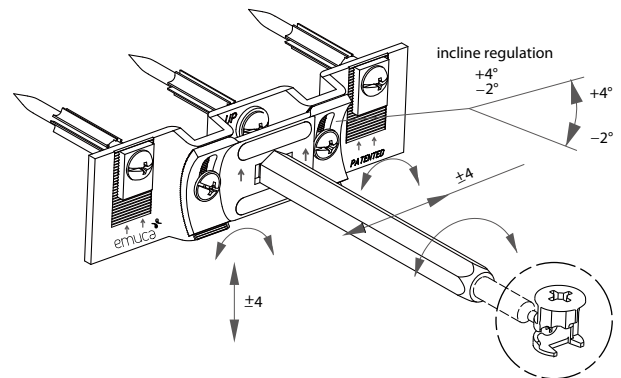
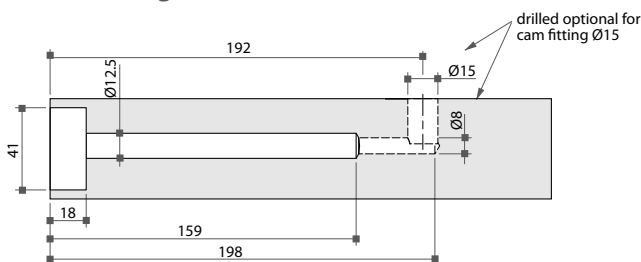

07-3 Glass Shelf Supports & Fittings

Concealed Wall Shelf Holder

- * Concealed shelf holder of zinc plated steel, including screws and wall plugs for wall fixing, Ø8mm drillhole
- * 3 independent adjustments: vertical, horizontal & inclination
- * Maximum distance between two shelf holders: 700mm
- * 3 holders are suggested for mounting distance beyond 900mm
- * For chipboard shelf of 25mm thickness minimum or honeycomb shelf of 50mm thickness minimum
- * For a stronger fixing, use an excenter with Ø15mm cam and dowel with M6 thread



58940 Concealed Shelf Holder

- * For shelves of 25mm thickness minimum and 300mm depth
- * Adjustments: vertical ± 3 mm, horizontal ± 4 mm, inclination $\pm 2^\circ$

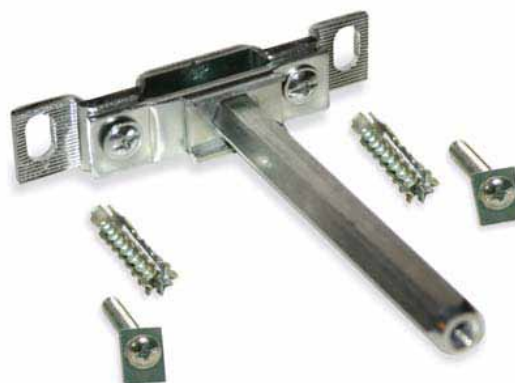
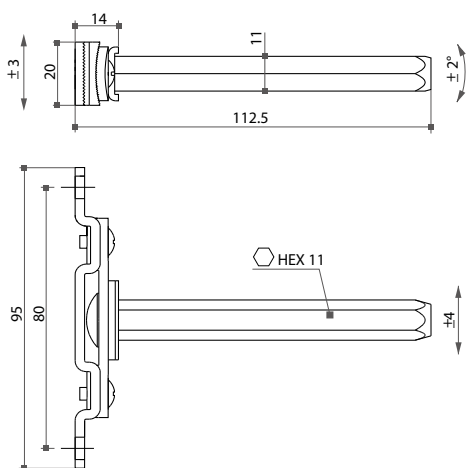

Machining assembling:

Direct

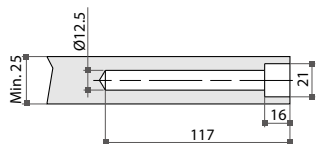

With excenter Ø15mm

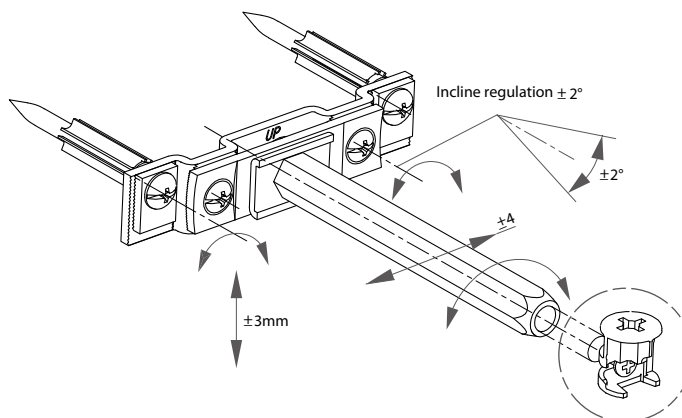
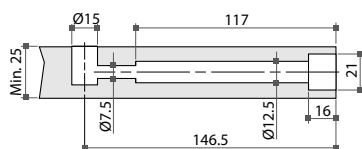

07-4 Shelf Supports & Fittings

Spoon Shelf Supports

- * Material: steel
- * Finish: brass or nickel plated

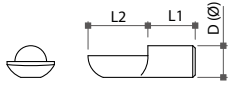

Sleeves

- * Material: steel
- * Finish: brass or nickel plated

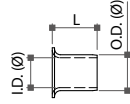

Item No.	D	L1	L2	Item No.	I.D.	O.D.	L
58290	Ø5mm	8mm	10mm	58275	Ø5mm	Ø5.5mm	6mm
58291	Ø1/4"	9.5mm	12mm	58271	Ø1/4"	Ø7.2mm	8mm
58292	Ø6mm	8mm	10mm	58273	Ø6mm	Ø6.9mm	8mm

58350 Solid Brass Shelf Support

- * Finish: original color or nickel plated
- * Ø1/4" pin

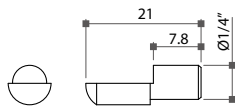

58360 Solid Brass Bushing

- * Finish: original color or nickel plated

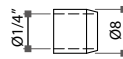

58280 Spoon Shelf Support

- * Material: steel
- * Ø1/4"x11mm pin
- * Finish: nickel plated

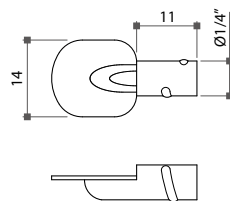

58524 Shelf Retainer

- * For insertion in Ø5mm hole at 32mm intervals
- * Material: plastic
- * Color: white
- * For shelf of 16mm thickness

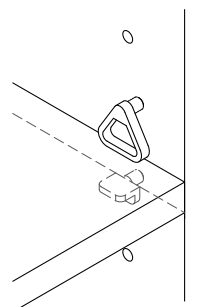
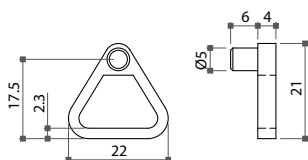

07-4 Shelf Supports & Fittings

58380 Steel Shelf Support

- * Material: steel
- * Finish: nickel plated
- * For Ø5mm drillhole

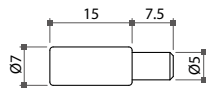

Item No.	Drillhole
58380	Ø5mm

Pin Shelf Support

- * Material: steel
- * Finish: nickel plated

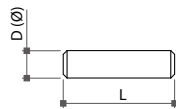

Item No.	Size (DxL)
58341	Ø5x25mm
58343	Ø5x16mm
58344	Ø5x45mm
58345	Ø6x40mm

58370 "Duplo" Shelf Support

- * Material: steel
- * Finish: nickel plated

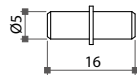

Item No.	Drillhole
58370	Ø5mm

L Shelf Support

- * Material: steel
- * Finish: brass, antique copper, black or nickel plated

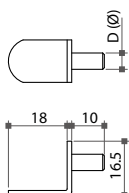

58300 / 58302

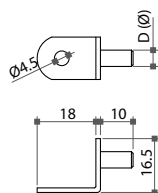

58331 / 58336
(with one screw hole)

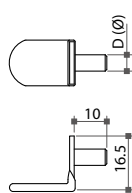

58310 / 58314
(with vinyl coating)



58300 / 58302



58310 / 58314
(with vinyl coating)



58331 / 58336
(with one screw hole)

Item No.	Drillhole
58300	Ø1/4"
58302	Ø5mm
58331	Ø1/4"
58336	Ø5mm
58310	Ø1/4"
58314	Ø5mm

07-4 Shelf Supports & Fittings

58445 Zinc Alloy Shelf Support

- * Material: zinc alloy
- * Finish: nickel plated
- * For Ø5mm drillhole

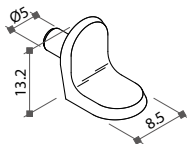

Item No.	Drillhole
58445	Ø5mm

58261 Shelf Support

- * Material: plastic
- * Color: brown, white or transparent
- * For Ø5mm drillhole

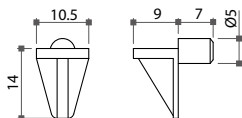

Item No.	Drillhole
58261	Ø5mm

58262 Shelf Support

- * Material: plastic
- * Color: brown or white
- * For Ø1/4" drillhole

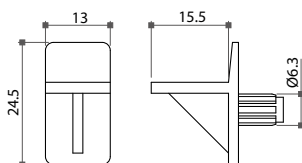

Item No.	Drillhole
58262	Ø1/4"

53875 Semi-Circle Nail Shelf Stud

- * Stud color: white, black or brown
- * With steel nail

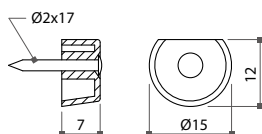

Item No.	Nail size
53875	Ø2x17mm

07-4 Shelf Supports & Fittings

5825 Series Safety Shelf Support

- * Steel pin in zinc or nickel plating
- * Plastic housing in white, brown, black or transparent
- * For Ø3mm or Ø5mm drillhole

58250

- * Steel pin for Ø5mm hole

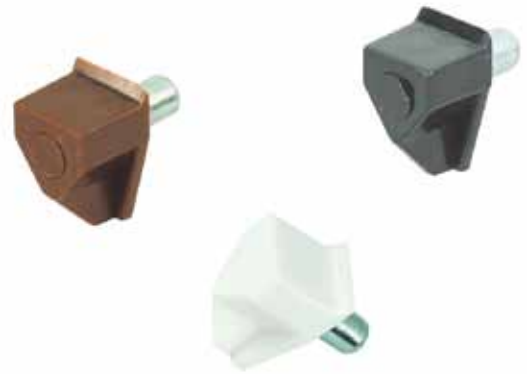
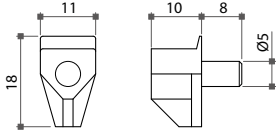

Item No.	Drillhole
58250	Ø5mm

58251

- * Steel pin for Ø3mm hole

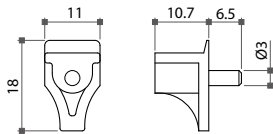

Item No.	Drillhole
58251	Ø3mm

58256

- * Steel pin for Ø3mm hole

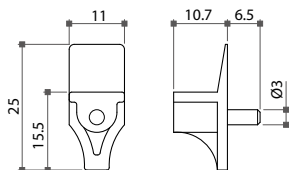

Item No.	Drillhole
58256	Ø3mm

07-4 Shelf Supports & Fittings

58453 Soft-Stay Shelf Support

- * Steel pin in nickel plating
- * Plastic housing in black, white or transparent
- * For Ø5mm drillhole
- * Soft thermo plastic rubber (TPR) to prevent slipping of glass and wooden shelf

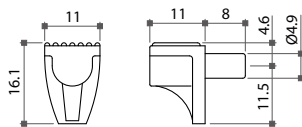

Item No.	Drillhole
58453	Ø5mm

58205 Flat Spoon Shelf Support

- * Steel pin in zinc plating
- * Plastic housing in white, brown or transparent
- * For Ø5mm drillhole

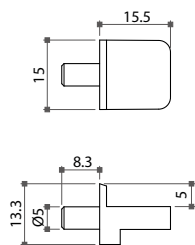

Item No.	Drillhole
58205	Ø5mm

58500 Soft-Touch Shelf Support

- * Material: steel
- * For Ø3mm or Ø5mm drillhole
- * With soft plastic rings to hold glass or wooden shelf
- * Finish: nickel plated

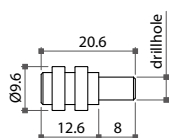

Item No.	Drillhole
58500-3	Ø3mm
58500-5	Ø5mm

58372 Glass Shelf Support

- * Material: steel
- * For Ø5mm drillhole
- * With a clear PVC tube
- * Finish: nickel plated

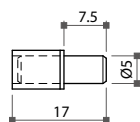

Item No.	Size
58372	Ø5x17mm L.

07-4 Shelf Supports & Fittings

58494 Glass Shelf Support

- * Material: zamak
- * Pin size: $\varnothing 5 \times 9 \text{mm}$
- * With glass sucker
- * Finish: nickel or brass plated

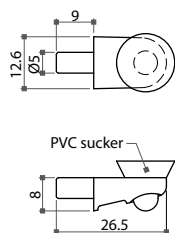

Item No.	Size
58494	12.6x26.5mm

58252 Safety Shelf Support

- * Clear transparent plastic housing with steel pin
- * For $\varnothing 5 \text{mm}$ drillhole
- * Only for 5mm glass thickness

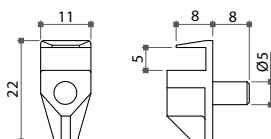

Item No.	Size
58252	$\varnothing 5 \times 17 \text{mm L.}$

20367 Glass Shelf Support

- * Material: steel
- * Pin size: $\varnothing 5 \times 9 \text{mm}$
- * Inner size: 8.2mm
- * For glass of 5 ~ 6mm thickness
- * Finish: black, brass or nickel plated

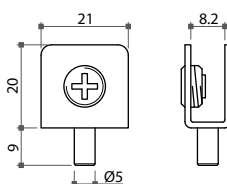
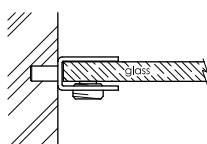

Item No.	Inner size	Glass thickness
20367	8.2mm	5 ~ 6mm

20375 Glass Shelf Support

- * Material: steel
- * For glass of 5 ~ 6mm thickness
- * With counter screw hole ($\varnothing 5.7 \text{mm}$)
- * Finish: nickel plated

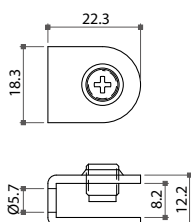

Item No.	Inner size	Glass thickness
20375	8.2mm	5 ~ 6mm

Алматы (7273)495-231
Ангарск (3955)60-70-56
Архангельск (8182)63-90-72
Астрахань (8512)99-46-04
Барнаул (3852)73-04-60
Белгород (4722)40-23-64
Благовещенск (4162)22-76-07
Брянск (4832)59-03-52
Владивосток (423)249-28-31
Владикавказ (8672)28-90-48
Владимир (4922)49-43-18
Волгоград (844)278-03-48
Вологда (8172)26-41-59
Воронеж (473)204-51-73
Екатеринбург (343)384-55-89

Иваново (4932)77-34-06
Ижевск (3412)26-03-58
Иркутск (395)279-98-46
Казань (843)206-01-48
Калининград (4012)72-03-81
Калуга (4842)92-23-67
Кемерово (3842)65-04-62
Киров (8332)68-02-04
Коломна (4966)23-41-49
Кострома (4942)77-07-48
Краснодар (861)203-40-90
Красноярск (391)204-63-61
Курск (4712)77-13-04
Курган (3522)50-90-47
Липецк (4742)52-20-81

Магнитогорск (3519)55-03-13
Москва (495)268-04-70
Мурманск (8152)59-64-93
Набережные Челны (8552)20-53-41
Нижний Новгород (831)429-08-12
Новокузнецк (3843)20-46-81
Ноябрьск (3496)41-32-12
Новосибирск (383)227-86-73
Омск (3812)21-46-40
Орел (4862)44-53-42
Оренбург (3532)37-68-04
Пенза (8412)22-31-16
Петрозаводск (8142)55-98-37
Псков (8112)59-10-37

Пермь (342)205-81-47
Ростов-на-Дону (863)308-18-15
Рязань (4912)46-61-64
Самара (846)206-03-16
Саранск (8342)22-96-24
Санкт-Петербург (812)309-46-40
Саратов (845)249-38-78
Севастополь (8692)22-31-93
Симферополь (3652)67-13-56
Смоленск (4812)29-41-54
Сочи (862)225-72-31
Ставрополь (8652)20-65-13
Сургут (3462)77-98-35
Сыктывкар (8212)25-95-17
Тамбов (4752)50-40-97

Тверь (4822)63-31-35
Тольятти (8482)63-91-07
Томск (3822)98-41-53
Тула (4872)33-79-87
Тюмень (3452)66-21-18
Ульяновск (8422)24-23-59
Улан-Удэ (3012)59-97-51
Уфа (347)229-48-12
Хабаровск (4212)92-98-04
Чебоксары (8352)28-53-07
Челябинск (351)202-03-61
Череповец (8202)49-02-64
Чита (3022)38-34-83
Якутск (4112)23-90-97
Ярославль (4852)69-52-93

Россия +7(495)268-04-70

Казахстан +7(7172)727-132

Киргизия +996(312)96-26-47

www.fourwinds.nt-rt.ru | | fse@nt-rt.ru